

AUTOMATIC TECHNOLOGY AUSTRALIA PTY LTD

CB-19 AUTOMATIC DUAL GATE CONTROLLER

OWNERS COPY

Installation Instructions

PN 13252

*Warning: Failure to comply with the
installation instructions and the
safety warnings may result in
serious personal injury and/or
property, opener or controller damage.*

CONTENTS

PAGE	CONTENTS
3	FEATURES
4	CONTROL BOARD LAYOUT
5	MENU STRUCTURE
6	INITIAL ELECTRICAL INSTALLATION
7	POWERING UP THE CONTROLLER
7	SETUP TRAVEL
7	LIMIT SWITCH / AMP TRAVEL SETUP
9	RE-PROFILING TRAVEL
10	SETTING TIMED TRAVEL
11	SETTING PEDESTRIAN POSITION
12	DESCRIPTION OF STANDARD OPERATION
13	CONTROL BOARD ADJUSTMENTS
13	MENU 2 CURRENT TRIPS
14	MENU 3 AUTO-CLOSE TIMES
14	MENU 4 LOCK TIMES
15	MENU 5 LIGHT TIMES
15	MENU 6 MOTOR SETTINGS
15	MENU 7 OPERATING MODES
17	PARAMETER VIEWING AND EDITING
18	TRANSMITTER OVERVIEW
18	BASIC CODE TRANSMITTER PROCEDURE
19	TRANSMITTER EDIT PROCEDURE
20	TRANSMITTER LIST MANAGEMENT
21	CODE OPERATION (LOCATION EMPTY)
21	CODE OPERATION (LOCATION USED)
21	DELETE OPERATION
21	EDIT OPERATION
21	COPY OPERATION
22	REMOTE CODE SET PROCEDURE
23	DIAGNOSTIC TOOLS (MENU 8)
23	MENU 8.1 TEST INPUTS
23	MENU 8.2 TEST TX'ERS
23	MENU 8.3 DISPLAY HISTORY
23	MENU 8.4 MEMORY USAGE
24	MENU 8.5 SERVICE COUNTER
24	MENU 8.6 COUNTERS
24	MEMORY TOOLS (MENU 9)
24	MENU 9.1 CLR CONTROL
24	MENU 9.2 CLR TX'ERS
25	SPECIFICATIONS
26	WARRANTY AND EXCLUSION OF LIABILITY

Automatic Technology Australia Pty Ltd to the extent that such may be lawfully excluded hereby expressly disclaims all conditions or warranties, statutory or otherwise which may be implied by laws as conditions or warranties of purchase of an Automatic Technology Australia Pty Ltd Sliding Gate Opener and Automatic Technology Australia Pty Ltd hereby further expressly excludes all or any liability for any injury, damage, cost, expense or claim whatsoever suffered by any person as a result whether directly or indirectly from failure to install the Automatic Technology Australia Sliding Gate Opener in accordance with these installation instructions.

FEATURES

Your CB-19 controller has many features which you will appreciate. The components and materials used in this Automatic gate controller are of the latest technology and highest quality. Listed below are some of the many features.

OPERATION

To operate the gate opener simply activate one the integrated controller's control inputs using a remote control transmitter, keypad or many other devices such as key switches, loop detectors etc. In response the gate will then open, stop or close as requested. Optionally, the controller can be configured to automatically close after operation using one of several auto-close modes.

OPERATOR CONSOLE

Incorporated into the CB-19 is a simple to use operator console which consists of several buttons and a display. The console greatly simplifies installation, adjustments and status indication. With the addition of the console, facilities which were only available on previous receivers using an additional hand held programmer are now available as standard via a simple menu system. Features include editing transmitter storage and names, setting various parameters, selecting specialized operating modes and performing system diagnostics.

HOPPING CODE TRANSMITTERS

The receiver incorporates a Hopping code remote control receiver. Hopping code systems work by the transmitters generating a new encrypted access code each time they are activated. As the receiver is able to follow the encryption sequence and also rejects any access code it has already received it is able to foil code breaking techniques used by thieves to gain unauthorized access. In addition to this, each hopping code transmitter has a unique serial number - so no two transmitters are alike. Further, with a huge error rejection rate which allows less than 1 error in 10^{19} the security of the remote control system is greatly enhanced.

SECURITY CODE STORE

The CB-19 uses state of the art technology in storing your selected transmitter security codes. Up to 511 different

transmitters can be stored in the memory with the facility to assign a 11 character ID label to each transmitter.

TRANSMITTER MANAGEMENT FLEXIBILITY

Whenever a large number of transmitters are used, managing those transmitter effectively is of great importance. The CB-19 provides many feature which enhance transmitter management. Transmitters can be listed by store location, group number, serial number or I.D label. Tools are available which allow transmitters to be Replaced, Deleted and Edited. A quick transmitter code set feature is provided which allows the button functions of an existing transmitter to be copied to all transmitters to be coded. This feature allows many transmitters to be coded without the need for the installer to touch any console buttons during the coding process. When all transmitters are coded, a transmitter storage report can be generated which can be easily transferred to a P.C for record keeping. Access logging can also be implemented by enabling the generation of a transmitter activity report each time the receiver is triggered.

VARIOUS TYPES OF DRIVE UNITS SUPPORTED.

The controller can be used with gate drive units that use micro-switches, mechanical stops or slip clutches. In addition to this the micro-switch type drive units can be wired using 3 or 5 wires.

EASE OF INSTALLATION

During installation the controller will automatically detect the wiring type and the number of motors connected. In addition the installer is guided through the steps of installation by first adjusting the travel limits (under motor power). This can be done via the console keypad or via a hand held transmitter (this allows the installer to closely observe and control the gates movement from any position rather than having to be within arms reach of the console). Once the limits have been adjusted, the controller will automatically learn the travel characteristic of each gate.

STATUS INDICATION

The status of the gate controller can be determined at anytime by observing the

console's screen. When the MAIN SCREEN is displayed, the current position of the gate or the result of the last movement can be viewed. The display will also show the count down progress of the auto-close timers. Any active input will also be displayed along with the state of various features such as periodic service, vacation mode, etc.

PASSWORD PROTECTION

All operating parameters and transmitter storage can be protected from being changed by unauthorized personnel by an optional password protection feature.

CONTROL OF LOCK AND LIGHTS

The incorporated controller has two programmable outputs which can be selected to operate an electric lock and warning or courtesy lights. The timing of these outputs can be adjusted to suit your needs. In addition a button on a remote control can be coded to operate the Light output.

EXTENSIVE OPERATING MODES VIA CONTROL INPUTS AND REMOTE CONTROL

The ontroller can be configured to operate in many different ways via its 8 control and safety inputs which include P.E, OPEN, STOP, CLOSE, OSC, SWIPE and PEDESTRIAN. Remote control operation is provided with each transmitter's button being able to be configured to operate one of OSC, PEDESTRIAN, SWIPE, CLOSE, OPEN, STOP, LIGHT or VACATION functions. The controllers functionality is further enhanced by 4 auto-close modes, 4 P.E response modes and two pedestrian response modes. For details refer to relevant instruction manual sections.

BATTERY BACKUP AND SOLAR OPERATION

The Automatic gate controller can be fitted with optional battery backup or solar chargers to provide operation during power outages or at unpowered sites respectively.

CONTROL BOARD LAYOUT

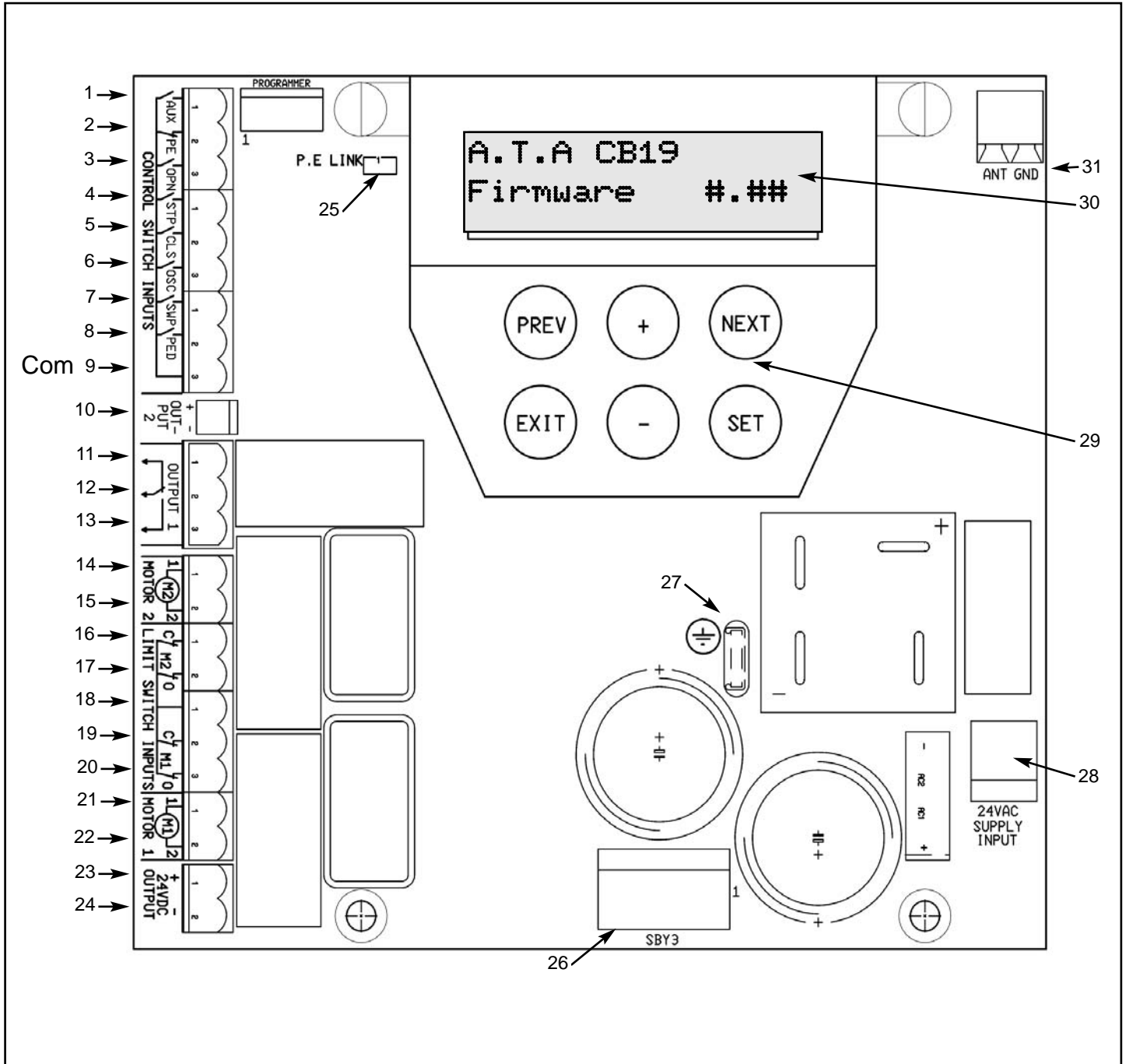

1	Aux control input	16	MOTOR 2 close limit switch input terminal
2	P.E N/C input terminal (remove 25 when used)	17	MOTOR 2 open limit switch input terminal
3	OPN N/O input terminal	18	COM terminal for Terminals 16,17,19 & 20.
4	STP N/O input terminal	19	MOTOR 1 close limit switch input terminal
5	CLS N/O input terminal	20	MOTOR 1 open limit switch input terminal
6	OSC N/O input terminal	21	MOTOR 1 terminal 1
7	SWP N/O input terminal	22	MOTOR 1 terminal 2
8	PED N/O input terminal	23&24	24VDC output for powering accessories
9	COM terminal for input terminals 1 to 8	25	PE input jumper (remove when 2 is used)
10	OUTPUT 2 (optional relay module coil drive output)	26	Standby battery / solar charger connector
11	OUTPUT 1 N/C relay contact	27	Mains Earth connection
12	OUTPUT 1 COM relay contact	28	24VAC power input (from transformer)
13	OUTPUT 1 N/O relay contact	29	Console keypad
14	MOTOR 2 terminal 1	30	Console display (LCD)
15	MOTOR 2 terminal 2	31	Antenna connector

MENU STRUCTURE

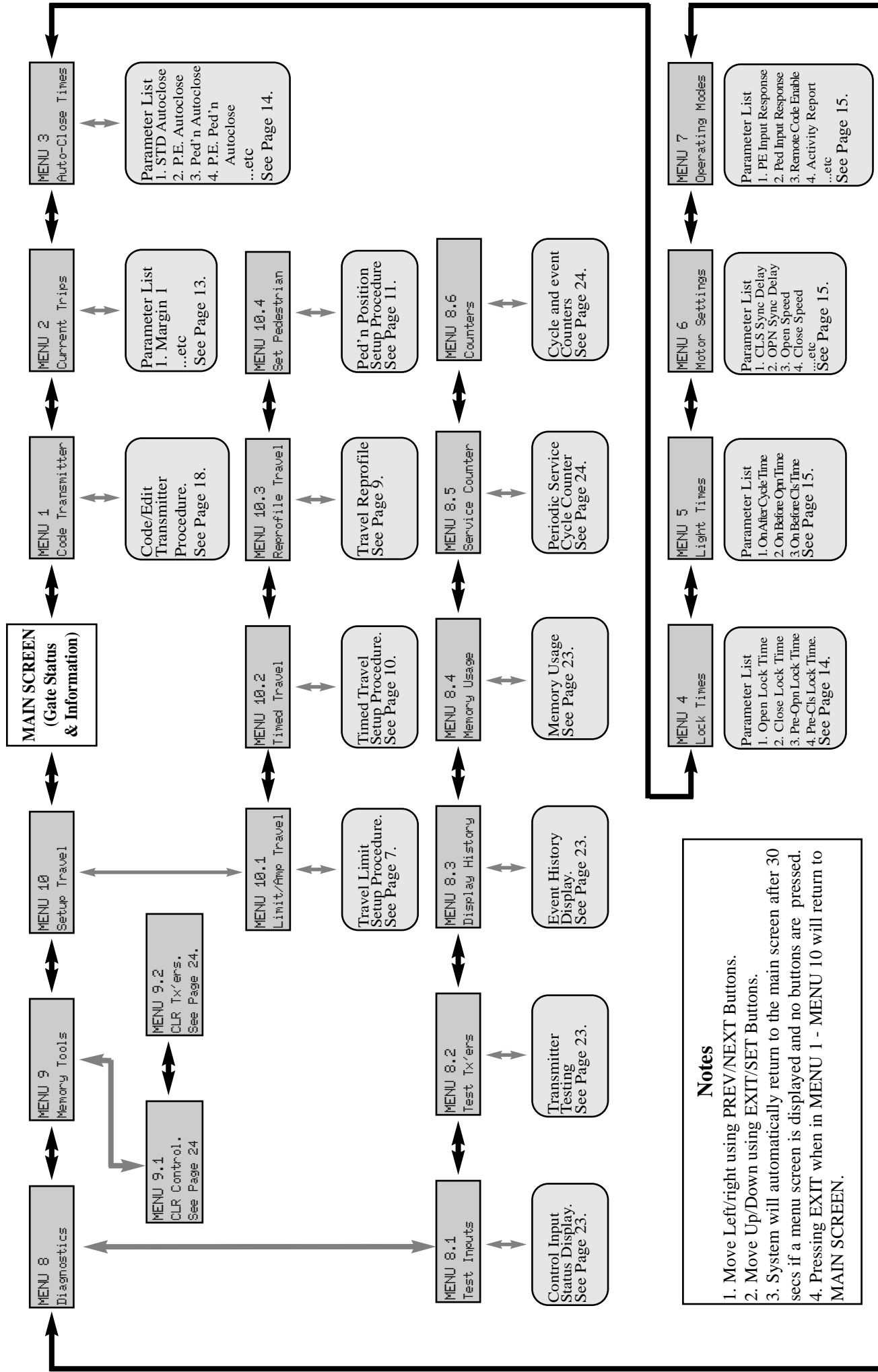

Notes

1. Move Left/right using PREV/NEXT Buttons.
2. Move Up/Down using EXIT/SET Buttons.
3. System will automatically return to the main screen after 30 secs if a menu screen is displayed and no buttons are pressed.
4. Pressing EXIT when in MENU 1 - MENU 10 will return to MAIN SCREEN.

INITIAL ELECTRICAL INSTALLATION

CAUTION:

CABLES WHICH HAVE A GREEN / YELLOW COLOURED INSULATION ARE FOR EARTHING PURPOSES ONLY. NEVER USE THESE CABLES FOR ANY OTHER PURPOSE.

STEP 1. WIRING MOTORS AND LIMITS SWITCHES

The CB-19 can be connected to the gate drive units in one of several ways. The figures below show the various wiring methods used for different drive unit types. Select the appropriate method for your drive unit. Note “non-motor current carrying limit-switch” type drive units can be connected using the standard 5 wire connections or a special 3 wire method that uses a single limit switch sense wire and two diodes. If two drive units are used, repeat the wiring for the second motor using the MOTOR 2 terminals. Note the drive unit connected to the MOTOR 1 terminals will open first and will be used for pedestrian access. The motor travel direction can be reversed by swapping the motor connections. An opportunity to confirm the correct motor polarity is provided during the limit setup procedure.

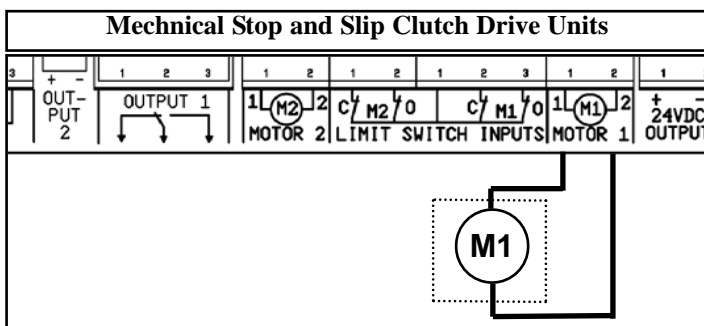
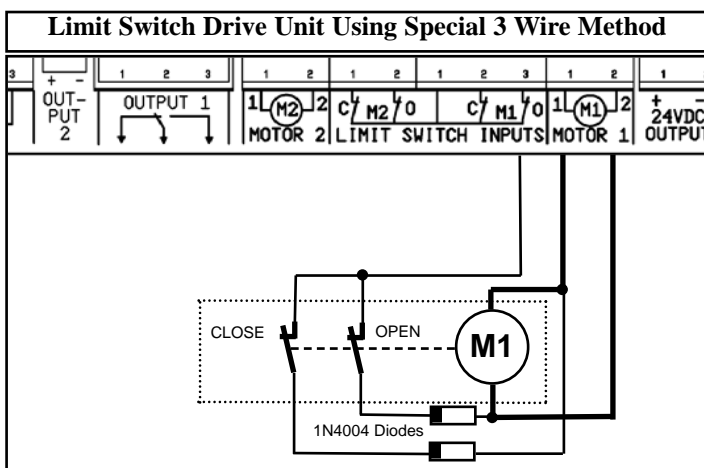
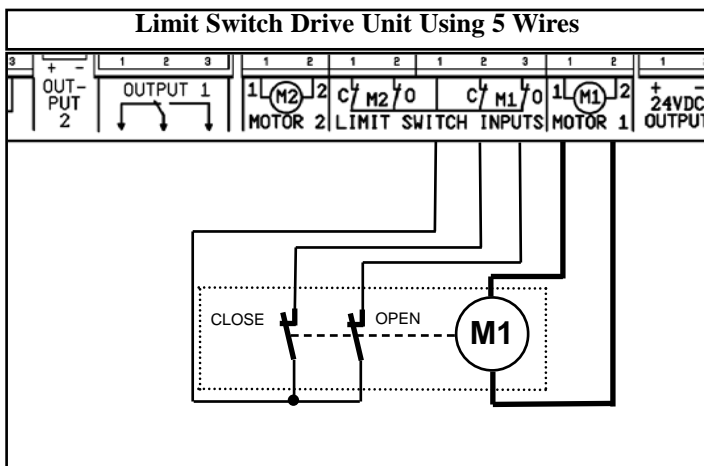

STEP 2. INSTALLING ANTENNA

Mount the antenna at the highest available position for optimal reception. Connect the signal and ground wires of the antenna coaxial cable to the CB-19's antenna connector. Do not cut the coaxial cable.

STEP 3. WIRING CONTROL SWITCH INPUTS

When remote control operation is only required the CB-19's control switch inputs are not utilised. It is, however, strongly advised that a Photo-electric Safety Beam be used to prevent the gate being driven closed when an object is present in the gate way. The other console switch inputs may be used for operating the gate via any device that provides a switch contact output. The figure below shows how to connect a Photo-electric Beam to the CB-19. Note the P.E LINK jumper must be removed when the PE input is used. The figure also shows the connections for a switch connected to the OSC control input.

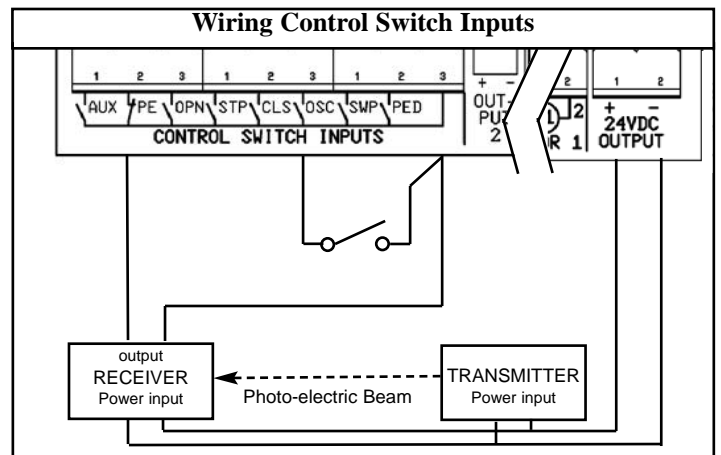

STEP 4. WIRING OUTPUT1 AND OUTPUT2

Outputs 1 and 2 are used to control a lock and a light. Which output is to control which function and the way it is controlled is programmable. **If using these outputs make sure that the functions are configured for correct operation prior to setting the travel limits.** OUTPUT1 is a relay output with high current capability. OUTPUT2 is used to activate an optional external relay module (RO-1) which in turn is used to switch the load (see figure below).

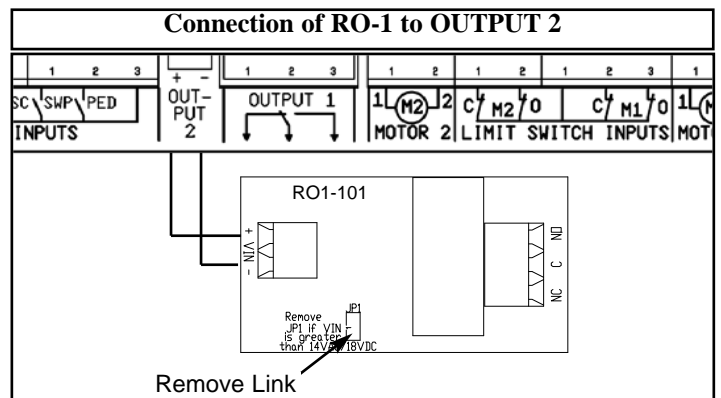

POWERING UP THE CONTROLLER

After checking the initial wiring, apply power to the CB-19. The controller will go through a startup sequence displaying the STARTUP SCREEN which indicates the controller type and firmware version. After a short delay the MAIN SCREEN will be displayed. If this is the first time the controller has been used, the

MAIN SCREEN should indicate that the limits are not set. If the display shows that some input is active then rectify the situation before proceeding. If a default setting is to be changed it should be done now before setting the travel limits.

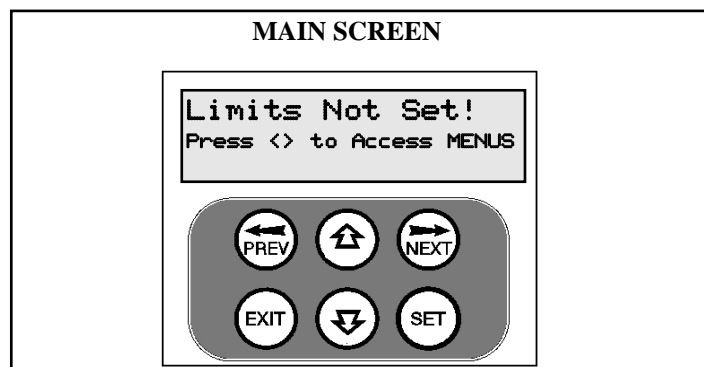
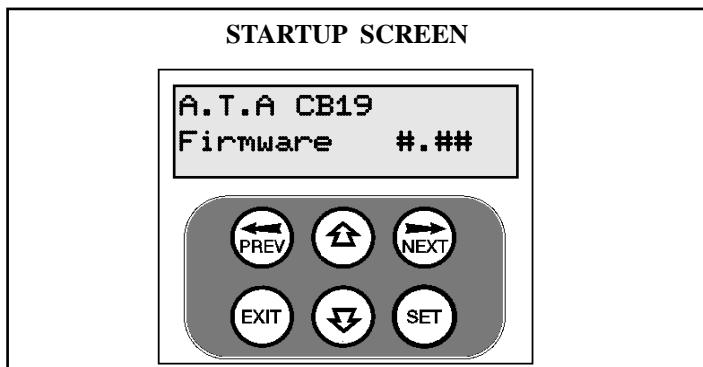

SETUP TRAVEL

The CB-19 can be used with drive units that use different methods to stop at the end of their travel.

The types supported are:

- A) Limit switch. Open and close limit switches indicate to the controller when the travel limit is reached.
- B) AMP trip limits. Travel limits are detected by and an increase in motor current as mechanical stops are reached.
- C) Timing. The motor is driven for a preset time. When the travel limit is reached a clutch incorporated into the drive unit allows the motor to keep turning for the remaining preset running time.

The setup procedure for each type of drive unit follow.

LIMIT SWITCH / AMP TRAVEL SETUP

This section shows how to set the travel limits for drive units with limit switches. The procedure can be partly completed using a remote control transmitter as a remote console. In order to use a remote control transmitter it must first have at least one of its buttons coded to the controller's receiver. The function assigned to the transmitter's buttons is of no concern here as the buttons are temporarily assigned to OPEN, CLOSE and SET. Refer to TRANSMITTER OVERVIEW.

Note: The limit setting procedure can be aborted at anytime by pressing EXIT.

STEP 1. NAVIGATING TO "LIMIT/AMP TRAVEL MENU"

To navigate to the Menu 10.1 from the MAIN SCREEN simply press PREV to display MENU 10, followed by SET to display MENU 10.1. Press SET again to start the limit setting procedure

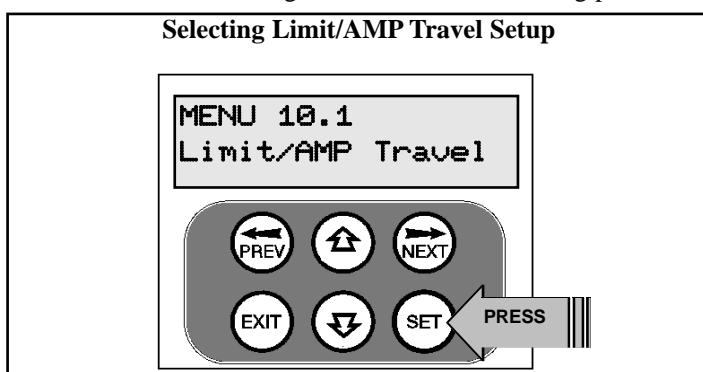

STEP 2. CONFIRMING READY TO START.

The CB-19 will prompt you to confirm that the motor wiring is complete and that the gate(s) are in a halfway position and engaged. Press SET to confirm.

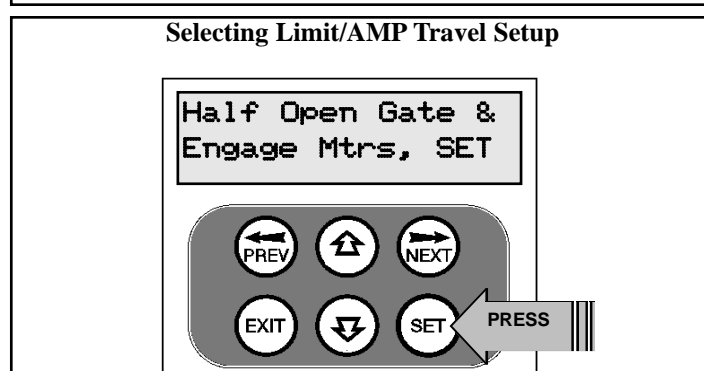
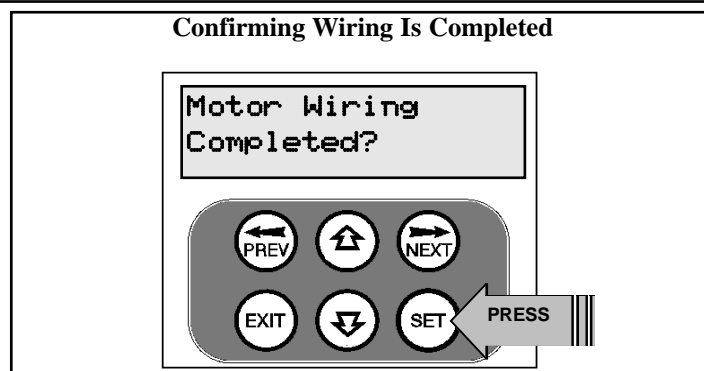

LIMIT SWITCH / AMP TRAVEL SETUP (cont)

STEP 3. CONFIRMING CORRECT WIRING DETECTED

The controller will now automatically detect the type of drive unit used by the number of wires used. If the correct number of wires is displayed then press SET to continue otherwise press EXIT and check the wiring.

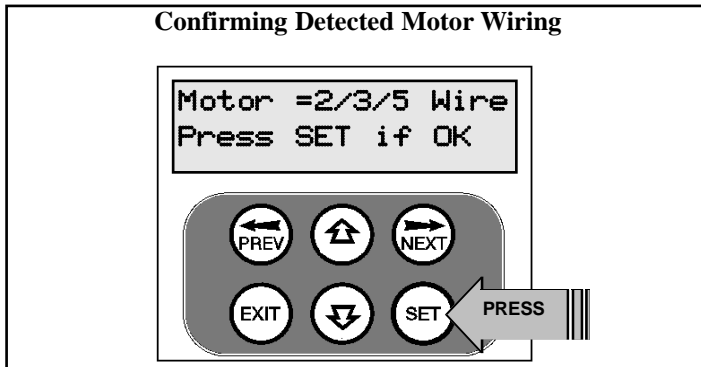

Continue from STEP 4A for 2WIRE (AMP TRAVEL) Setup.

STEP 4. CONFIRMING MOTORS DETECTED.

The controller will now automatically detect if one or two motor are connected. If the correct number is displayed then press SET to confirm otherwise press EXIT and check the wiring.

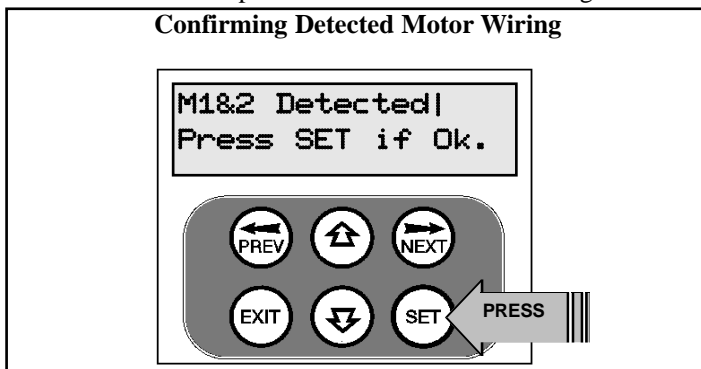

STEP 5. ADJUSTING CLOSE LIMIT(S).

The controller will now prompt for the motor(s) to be driven to the desired close limit and for the limit switches to be adjusted so that the motor stops at the desired position. The motor can be driven using the UP and DOWN buttons on the console keypad or Button 1 and 4 of a transmitter. After making adjustments to the limit switch positions always re-approach the limit at full speed by

driving the motor open a short distance and then driving it close again. When the close limit has been adjusted press SET to continue. Note: If the motor drives in the wrong direction (UP closes gate / DOWN opens gate) the motor wires need to be swapped.

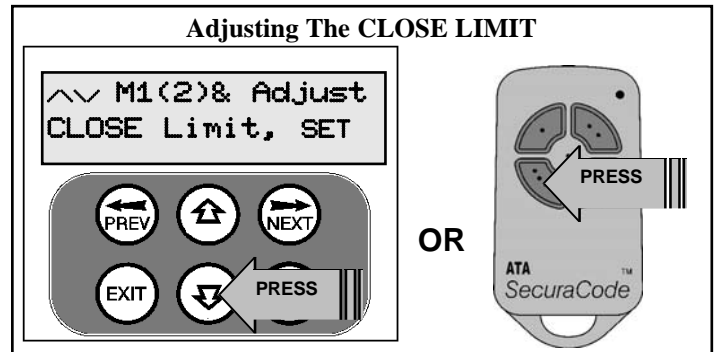

STEP 6. ADJUSTING OPEN LIMIT(S).

The controller will now prompt for the motor(s) to be driven to the desired open limit and for the limit switches to be adjusted so that the motor stops at the desired position. The motor can be driven using the UP and DOWN buttons on the console keypad or Button 1 and 4 of a transmitter. After making adjustments to the limit switch positions always re-approach the limit at full speed by driving the motor close a short distance and then driving it open again. When the open limit has been adjusted press SET.

STEP 7. AUTOMATIC PROFILING

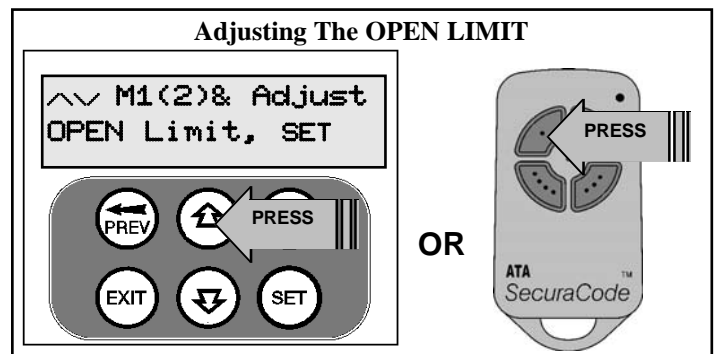

After a brief pause the controller will automatically close and open gate several times and learn the gates load and travel characteristics. When the setup is complete the MAIN SCREEN will be displayed with the gate shown to be OPEN. The Gate can now be used.

AMP TRAVEL SETUP (Step 4A)

STEP 4A. SELECTING THE NUMBER OF MOTORS.

The controller will now prompt for the number of motors con-

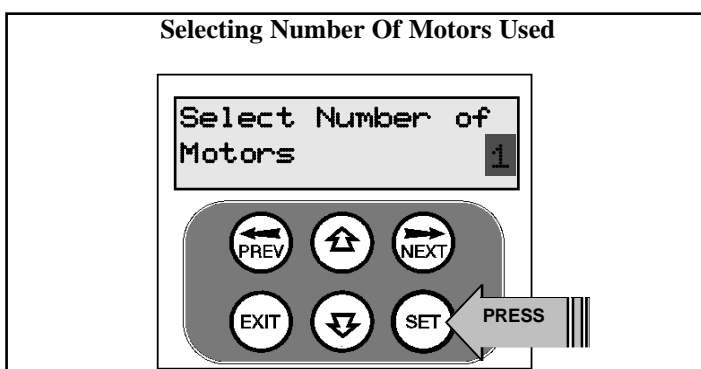

nected to be entered. Use the UP or DOWN key to select the correct number and then press SET.

STEP 5A. TEST AND ADJUST STOP DETECTION CURRENT TRIP LEVELS.

Note: If a dual gate installation is being used, steps 5A and 6A will be undertaken for motor 2 and then motor 1.

For this type of installation the controller detects the travel limits by sensing a motor current trip when the mechanical stop is reached.. In this step, the stop detection current trip levels for each motor are tested and adjustments made to obtain the optimum level. A high value results in undue force, while a low value will result in the gate stopping midway due to variations in friction etc. continued...

AMP TRAVEL SETUP (cont)

STEP 5A. (cont)

Using the Up / DOWN keys drive the motor into the close and open stops and adjust the stop current trip levels. The motor should be driven into each mechanical stop at full speed until the controller senses a current trip and stops the motor.

Note: If the motor drives in the wrong direction (UP closes gate / DOWN opens gate) the motor wires need to be swapped over.

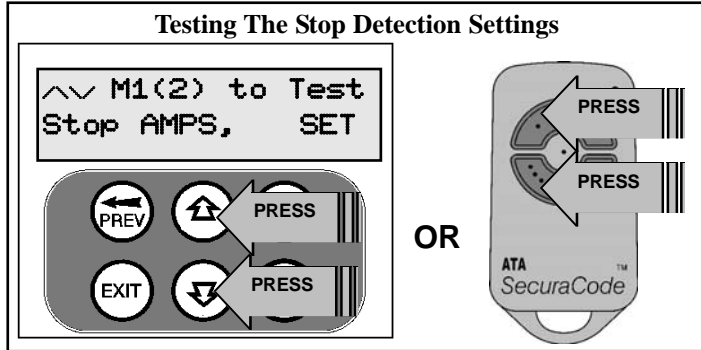

The trip current for each direction can be view and adjusted by pressing the NEXT key on the keypad.

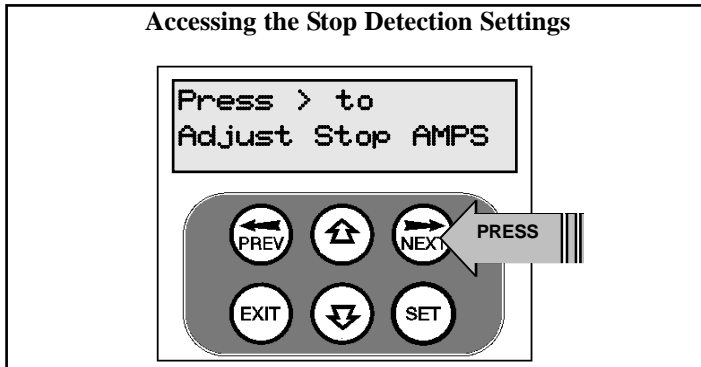

See PARAMETER VIEW AND EDIT for adjustment procedure.

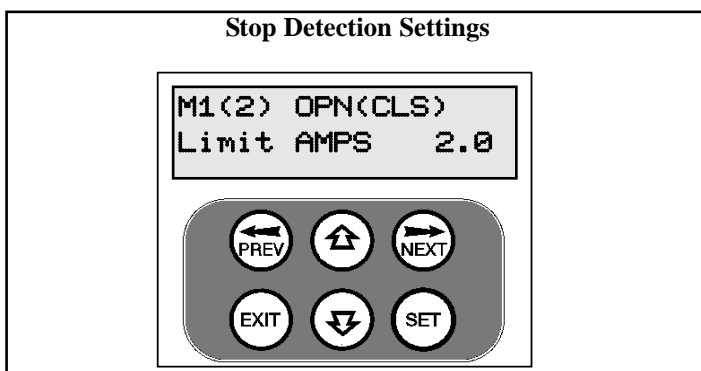

STEP 6A. CONFIRMING SETTINGS

When the settings have being adjusted correctly, drive the gate to the open stop and then press the SET Key.

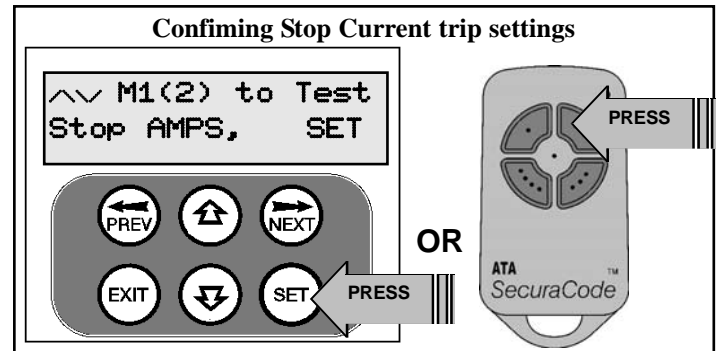

As step 7A requires the gate to be open, the controller will prompt you to confirm the gate leaf is in the open position. Press SET to confirm or press EXIT to go back and drive the gate open.

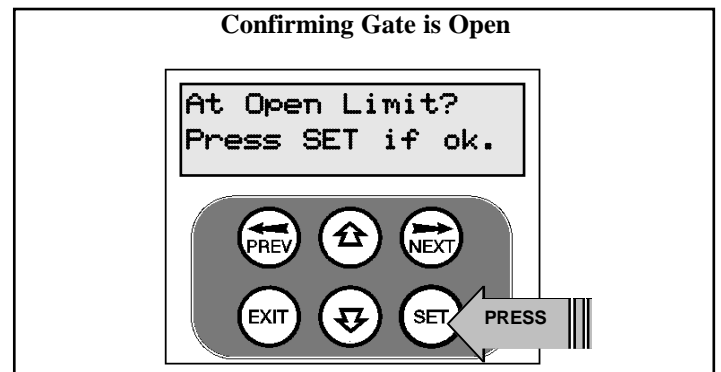

STEP 7A. AUTOMATIC PROFILING

After a brief pause the controller will automatically close and open gate several times and learn the gates load and travel characteristics. When the setup is complete the MAIN SCREEN will be displayed with the gate shown to be OPEN. The Gate can now be used.

RE-PROFILING TRAVEL

Reprofiling is a simplified way of re-learning the travel charastics of a previously setup Limit Switch/AMP travel installation. Re-profiling can be used when the travel limits of a gate are altered or when the travel characteristics of the gate change due to mechanical adjustments etc. To initiate a re-profile simply locate "MENU 10.3 Reprofile Travel" and press SET then follow the prompts. The reprofile feature will also be automatically started when a control parameter is altered which affects the gates travel. Reprofile is not available for TIMED TRAVEL installations.

SETTING TIMED TRAVEL

This section shows how to set the travel times when using drive units with slip clutches etc. Two methods are available for setting up the travel times. The first allows the installer to drive the motor(s) so that the actual travel time can be recorded. The second allows exact times to be entered. **Note: The limit setting procedure can be aborted at anytime by pressing EXIT.**

STEP 1. NAVIGATING TO "TIMED TRAVEL MENU"

To navigate to the Menu 10.2 from the MAIN SCREEN simply press PREV, SET then NEXT. Press SET to start the setup.

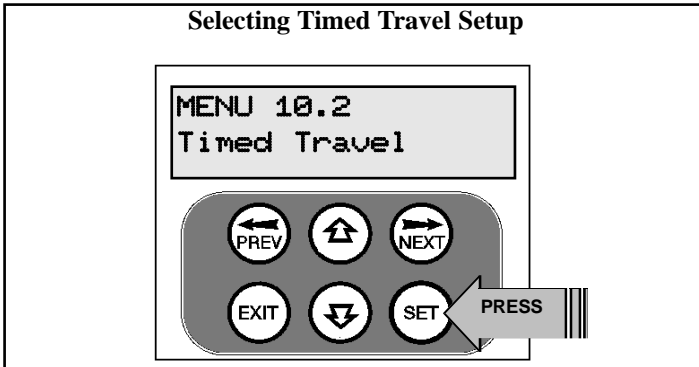

STEP 2. CONFIRMING READY TO START.

The CB-19 will prompt you to confirm that the motor wiring is complete. Press SET to continue.

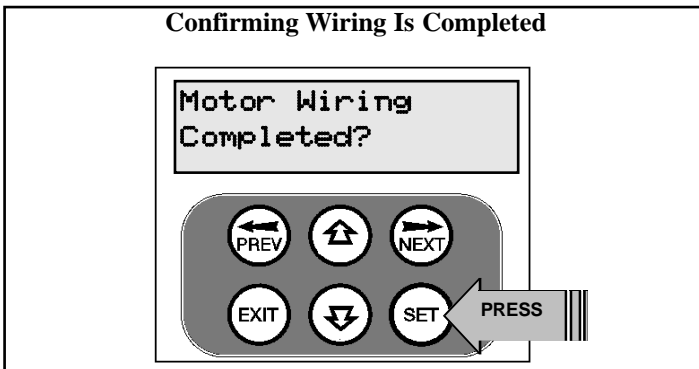

The controller will now prompt you to confirm that you understand that **no current trip obstruction detection is available** when using timed travel. Press SET if you accept this.

Confirming Obstruction Detection is Disabled

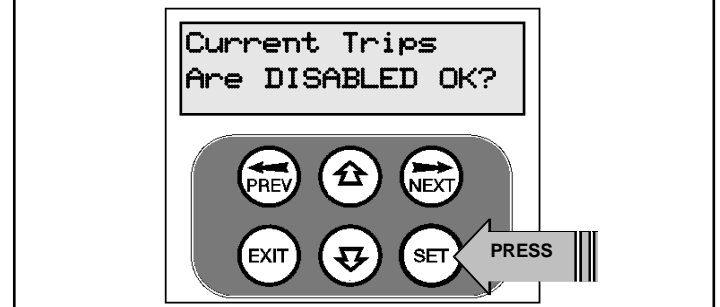

STEP 3. SELECTING THE NUMBER OF MOTORS.

The controller will now prompt for the number of motors to be entered. Use the UP or DOWN key to select the correct number and then press SET.

STEP 4. SELECTING SETUP METHOD.

The controller will now prompt for the setup procedure to be selected. Press SET to set the travel times by actually driving the motor(s) or press EXIT to enter exact time parameters. Continue with STEP 5 if "DRIVE MOTORS" is selected or go to STEP 5A if "ENTER TIMES" is selected.

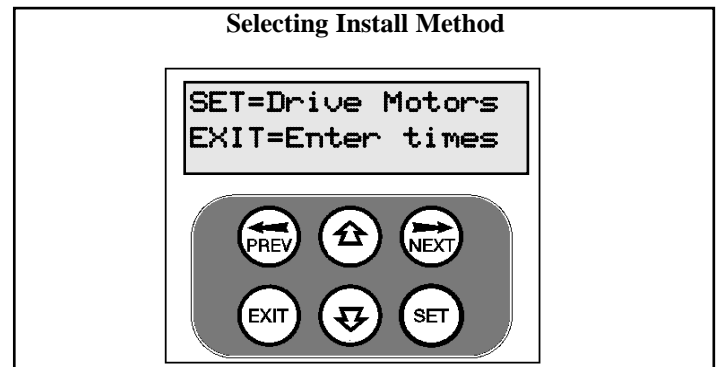

SETTING TIMED TRAVEL - DRIVE MOTORS

STEP 5. ADJUSTING GATE LEAF SYNCHRONIZING DELAYS. (Dual gate installations only)

For dual gate installations, the controller will prompt for you to edit the gate leaf synchronizing delays. The settings are used to introduce a delay between when the motors start so that overlapping gates are opened and closed in the correct order. Press EXIT

to continue with STEP 6 or press SET to access the gate leaf synchronizing delay parameters. See PARAMETER VIEW AND EDIT for adjustment procedure.

STEP 6. CONFIRMING GATE IS OPEN.

The controller will now prompt for you to confirm that the gate is open. If the gate is open press SET and continue with STEP 7.

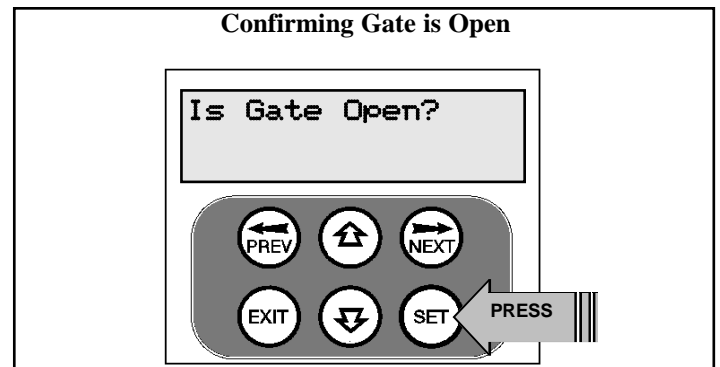
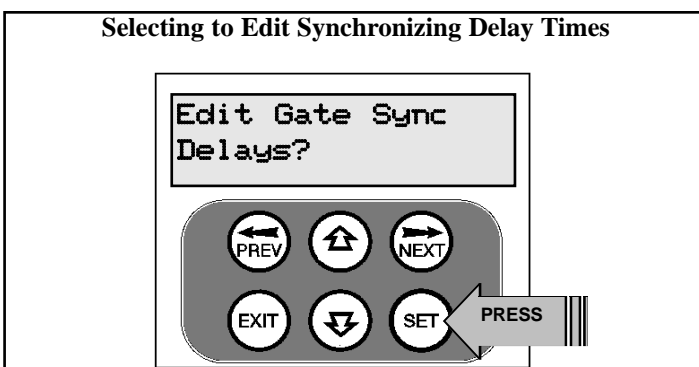

SETTING TIMED TRAVEL - DRIVE MOTORS (cont)

Press EXIT if the gate is not open and the controller will now prompt for the gate to be opened by holding the UP key. When the UP key is released the motor(s) will stop and STEP 6 restarted. Note: If the motor drives in the wrong direction the motor wiring needs to be swapped.

Opening Gate in Preparation For Setting Travel Times

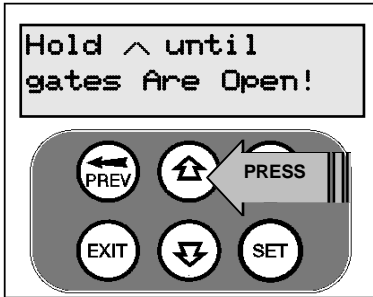

STEP 7. SETTING CLOSE CYCLE DRIVE TIME.

The controller is now ready for the close cycle drive time to be set. To do this simply press and hold the DOWN key until the gate is driven fully closed. Note: If the motor drives in the wrong direction the motor wiring needs to be swapped.

Setting Close Cycle Time

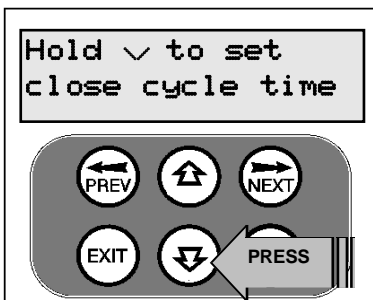

STEP 8. SETTING OPEN CYCLE DRIVE TIME.

The controller is now ready for the open cycle drive time to be set. To do this simply press and hold the UP key until the gate is driven fully open.

Setting Open Cycle Time

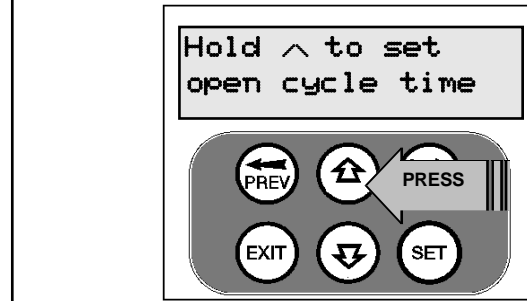

STEP 9. CONFIRMING SETTINGS.

The controller will now prompt you to save the settings. Press EXIT to restart from STEP 6 or, if you are happy with the settings press SET and the main screen will be displayed and the gate is ready to be used.

Confirming Settings

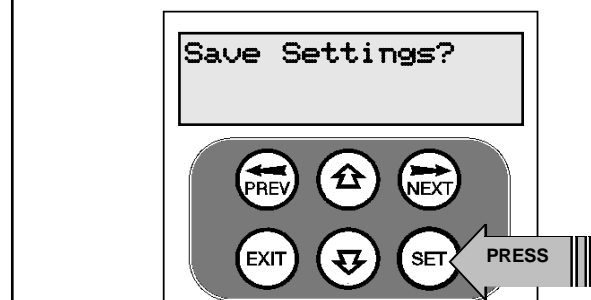

SETTING TIMED TRAVEL - ENTER TIMES

STEP 5A. ENTERING TIMED TRAVEL PARAMETERS.

When the ENTER TIMES method is selected a list of parameters is provided to configure the gates travel. The parameters provided are listed below with a brief description.

- M1 Normal Open Time -Sets Open drive time for M1
- M1 Normal Close Time -Sets Close drive time for M1
- M2 Normal Open Time -Sets Open drive time for M2*
- M2 Normal Close Time -Sets Close drive time for M2*
- Close Sync Delay -Sets Delay before M1 is started on close cycles*

Open Sync Delay -Sets Delay before M2 is started on open cycles*

*Only used for dual gate installations.

Once the parameter values have been set press EXIT and the main screen is displayed and the gate is ready for use.

SETTING PEDESTRIAN ACCESS POSITION

The controller can be instructed, via its pedestrian control feature, to partly open and provide pedestrian access but prevent vehicular access. This is achieved by partly opening the motor 1 gate leaf. If dual motors are used, motor 2's gate leaf is held closed. The partly open position of motor 1's gate leaf is initially set to a position halfway between open and closed. This initial position can be adjusted by the installer to any position within the gates travel range by selecting a pedestrian access travel time (from closed).

The setting is accessed from "MENU 10.4 Set Pedestrian". The time is adjustable in 1 second steps.

DESCRIPTION OF STANDARD OPERATION

This section describes the standard operation of the control board with the factory set default values.

MOTOR CONTROL.

The controller drives the motor in the appropriate direction as instructed by the control inputs. Once a cycle is started the motor will continue to travel until:

- 1.The controller is instructed to stop by a control input.
- 2.The motor's travel limit is reached.
- 3.The motor is obstructed, overloaded or stalls

When the control inputs instruct the control board to change the motor direction, the controller brakes the motor, waits for the motor to stop and then starts the motor in the other direction.

MOTOR OBSTRUCTION DETECTION (only supported with limit switch type drive units)

If a motor is obstructed while opening, the motor is stopped. If the motor is obstructed while closing, the motor is stopped and then reversed to the open position. Obstruction detection is achieved by monitoring the motor's current and comparing it to the "normal" current profile for the motor. If the current of the motor rises above the "normal" by the MARGIN AMP setting, then the motor is said to be obstructed. In addition to the normal motor obstruction detection, motor overload and stall detection is provided to protect the gate opener and controller.

MOTOR SPEED CONTROL

The motor's speed is controlled by varying the voltage applied to the motor. When the motor is started its voltage is ramped up to the OPEN or CLOSE Speed Voltage parameter. When the limit switch of a drive unit is activated the motor is braked so as to come to a rapid but gentle stop.

LOCK RELEASE OUTPUT

The lock release output is configured to pulse for 0.5 seconds at the start of each cycle. The output is turned on at the same time the motors are started. The output is provided on OUTPUT1.

COURTESY LIGHT

The courtesy light is normally used to illuminate the driveway etc. The light will be turned on each time the gate is activated (day or night) and automatically turned off 1 minute after the drive cycle has finished. The light can also be activated and deactivated by pressing a transmitter button assigned the LGT function. The light output is provided on OUTPUT2 (requires additional light relay module RO-1).

OPEN / STOP / CLOSE (OSC) INPUT

(Activated by OSC terminal with N/O switch or by transmitter button with OSC function assigned)

If the gate is stopped the OSC input will cause the gate to move in the opposite direction to that last travelled. If the gate is moving the OSC input will cause the gate to stop.

PEDESTRIAN ACCESS (PED) FUNCTION

(Activated by PED terminal with N/O switch or by transmitter button with PED Function assigned)

The pedestrian access operation partly opens the gate to allow pedestrian access but prevent vehicle access. The position the gate

leaf is driven to is automatically set to halfway during setting of the travel limits, but can be manually selected. Pedestrian access mode is entered when the input is activated and the gate is in the closed position. If the gate is not in the pedestrian access mode, the PED input will stop the gates if moving, or close the gates, if stopped. While in pedestrian access mode, the pedestrian access position temporarily becomes the open limit for the gate leaf. The PED input then acts with an OSC type function. The pedestrian access mode is exited when the gate is closed or when another input is activated.

CLOSE (CLS) INPUT

(Activated by CLS terminal with N/O switch, by transmitter button with CLS function assigned or by console's DOWN button) Activating the CLS input will cause the gate to close. Holding the input active will prevent opening.

SWIPE (SWP) INPUT

(Activated by SWP terminal with N/O switch or by transmitter button with SWP function assigned)

Activating the the SWP input will cause the gate to be opened. If the terminal input is held it will prevent the gate being closed. The swipe input also effects P.E TRIGGERED AUTO CLOSE.

OPEN (OPN) INPUT

(Activated by OPN terminal with N/O switch, by transmitter button with OPN function assigned or by console's UP button)

Activating the OPN input will cause the gate to open. Holding the input will prevent closing.

STOP (STP) INPUT

(Activated by STP terminal with N/O switch, by transmitter button with STP function assigned or by console's EXIT button)

Activating the STP input while the gate is moving will cause the gate to be stopped. If the STP terminal is held it will prevent the gate from being moved.

PHOTOELECTRIC SAFETY BEAM (P.E) INPUT

(Activated by PE terminal with N/C switch)

When the P.E input is active, the gate is prevented from being closed. If the P.E input is triggered while the gate is closing, the controller will stop the motors and then open the gate. The P.E input has no effect while the gate is opening.

VACATION MODE

The controller supports a vacation mode where remote control access is disabled. The mode is activated by pressing a transmitter button with the VAC function assigned until the console displays that vacation mode is enabled (approx. 5 seconds). When activated any transmitter button which is assigned VAC will be ignored. To turn the Vacation mode off simple press a transmitter button with the VAC function assigned (Only requires a brief activation.) Vacation mode can also be turned on or off manually by editing the VACATION MODE parameter.

CONTROL BOARD ADJUSTMENTS

The control board's standard operation is altered by editing various control parameters. This section describes the parameters and the effect they have. Use the **PARAMETER VIEWING AND EDITING PROCEDURE** to access the parameters.

MENU 2 CURRENT TRIPS

The current trip parameters available depends on the type of drive unit used in the installation. The tables below show the parameters grouped by installation type.

PARAMETER (LIMIT SWITCH)	MIN	MAX	DEFAULT	STEP	UNITS	MENU #
MARGIN 1 AMPS Sets Motor 1 obstruction detection margin	0.0	2.0	0.5	0.1	AMPS	2
MARGIN 2 AMPS Sets Motor 2 obstruction detection margin	0.0	2.0	0.5	0.1	AMPS	2
MAX STARTUP AMPS Sets maximum permitted starting current of motors	0.0	10.0	10.0	0.1	AMPS	2
PROFILING Enables Motor Current VS Drive Time profiling	OFF	ON	ON			2
CUTOUT AMPS Maximum motor current permitted after startup	0.0	10.0	10.0	0.1	AMPS	2
SETTLE TIME Motor startup time during which MAX STARTUP AMPS applies	0.1	25.5	1.0	0.1	SEC	2
AMP TRIP LIMIT Motor drive electronics current limit	0	13	13	1	AMPS	2

PARAMETER (AMP LIMITS)	MIN	MAX	DEFAULT	STEP	UNITS	MENU #
MOTOR 1 OPEN LIMIT AMPS Sets Motor 1 open limit detection current	0.0	5.0	2.0	0.1	AMPS	2
MOTOR 1 CLOSE LIMIT AMPS Sets Motor 1 close limit detection current	0.0	5.0	2.0	0.1	AMPS	2
MOTOR 2 OPEN LIMIT AMPS Sets Motor 2 open limit detection current	0.0	5.0	2.0	0.1	AMPS	2
MOTOR 2 CLOSE LIMIT AMPS Sets Motor 2 close limit detection current	0.0	5.0	2.0	0.1	AMPS	2
MAX STARTUP AMPS Sets maximum permitted starting current of motors	0.0	6.0	5.0	0.1	AMPS	2
SETTLE TIME Motor startup time during which MAX STARTUP AMPS applies	0.1	25.5	1.0	0.1	SEC	2
AMP TRIP LIMIT Motor drive electronics current limit	0	13	13	1	AMPS	2

PARAMETER (TIMED TRAVEL)	MIN	MAX	DEFAULT	STEP	UNITS	MENU #
CUTOUT AMPS Maximum motor current permitted after startup	0.0	10.0	10.0	0.1	AMPS	2
MAX STARTUP AMPS Sets maximum permitted starting current of motors	0.0	6.0	5.0	0.1	AMPS	2
SETTLE TIME Motor startup time during which MAX STARTUP AMPS applies	0.1	25.5	1.0	0.1	SEC	2
AMP TRIP LIMIT Motor drive electronics current limit	0	13	13	1	AMPS	2

CONTROL BOARD ADJUSTMENTS (cont)

MENU 3 AUTO-CLOSE TIMES

The auto-close modes automatically close the gate after it has been operated. To implement this, the controller starts a timer once the gate has reached its desired open position. The timer then counts down and when it expires the controller starts to close the gate. Details about the four auto-close modes follow.

STANDARD AUTO-CLOSE

This mode is selected by entering a non-zero time for the **STD Autoclose** parameter. When selected the gate will auto-close after being fully opened (except when the gate has reversed to the open position after a motor obstruction or overload). Countdown is suspended by the P.E, OPN or SWP input being active. The countdown is aborted if the STP input is activated. The countdown will restart if the gate is open and OPN or SWP is activated.

P.E TRIGGERED AUTO-CLOSE

This mode is selected by entering a non-zero time for the **“P.E Autoclose”** parameter. This mode is used to auto-close the gate but only after a vehicle has passed through the gateway and triggered the P.E input. The swipe input can be used to clear the P.E triggered status so that the P.E input must be activated again before the countdown will start. As with the other P.E modes the STP input will abort countdown and the OPN and SWP inputs will restart the countdown if the gate is OPEN.

PEDESTRIAN ACCESS AUTO-CLOSE

This mode is selected by entering a non-zero time for the **“Ped’n**

A/C” parameter. When selected the gate will auto-close after being opened for pedestrian access unless it was following a reverse from an obstruction.

P.E TRIGGERED PEDESTRIAN AUTO-CLOSE

This mode is selected by entering a non-zero time for the **“P.E Ped’n A/C”** parameter. This mode is the same as the P.E triggered auto-close mode but it only operates during pedestrian access. As the SWP input is not available during pedestrian access, the PED input can be configured to act in a SWP mode by setting the **“PED I/P = PED SWIPE MODE”** parameter to ON.

AUTO-CLOSE AFTER OBSTRUCTION

Two parameters are provided to enable the auto-close feature to be activated after obstructions. Normally the auto-close feature is not enabled after obstructions for safety reasons. A P.E beam must be used for these features to be activated.

AUTO-CLOSE AFTER POWER UP

Auto-close after power up is normally not enabled for safety reasons but can be enabled if desired by setting this parameter to ON.

PARAMETER	MIN	MAX	DEFAULT	STEP	UNITS	MENU #
STD AUTOCLOSE TIME Sets and enables the standard auto-close time.	0.0	300.0	0.0	1.0	SEC	3
P.E AUTOCLOSE TIME Sets and enables the P.E triggered auto-close time.	0.0	60.0	0.0	1.0	SEC	3
PEDESTRIAN AUTOCLOSE TIME Sets and enables the Pedestrian auto-close time.	0.0	60.0	0.0	1.0	SEC	3
P.E PEDESTRIAN AUTOCLOSE TIME Sets and enables the PE Pedestrian auto-close time	0.0	60.0	0.0	1.0	SEC	3
AUTOCLOSE AFTER CLOSE OBSTRUCTION Enables autoclose feature after close obstructions	OFF	ON	OFF			3
AUTOCLOSE AFTER OPEN OBSTRUCTION Enables autoclose feature after open obstructions	OFF	ON	OFF			3
AUTOCLOSE AFTER POWER UP Enabled auto-close after power up	OFF	ON	OFF			3

MENU 4 LOCK TIMES

The control board’s lock function can be programmed for both hold and pulse operation. The lock output can also be programmed to activate prior to the motor starting. The open cycle

and close cycle actions can be programmed differently. The lock can be either OUTPUT1 or OUTPUT2 (see OPERATING MODES).

PARAMETER	MIN	MAX	DEFAULT	STEP	UNITS	MENU #
OPEN LOCK TIME Set the time the lock is activated for on open cycles	0.0	HOLD	0.5	0.1	SEC	4
CLOSE LOCK TIME Set the time the lock is activated for on close cycles	0.0	HOLD	0.5	0.1	SEC	4
PRE-OPEN LOCK TIME Time the lock is activated for prior to opening.	0.0	25.5	0.0	0.1	SEC	4
PRE-CLOSE LOCK TIME Time the lock is activated for prior to closing	0.0	25.5	0.0	0.1	SEC	4

CONTROL BOARD ADJUSTMENTS (cont)

MENU 5 LIGHT TIMES

The control board's light function can be programmed to operate a courtesy light or a warning light. The time the light stays on for after a cycle is adjustable. The light can also be activated prior to

the gate moving so that a warning can be given of the pending movement.g. Note the light output can be selected to be either OUTPUT1 or OUTPUT2. The parameters are shown below.

PARAMETER	MIN	MAX	DEFAULT	STEP	UNITS	MENU #
ON AFTER CYCLE LIGHT TIME Time light remains on for after a cycle	0	255	60	1	SEC	5
ON BEFORE OPEN CYCLE LIGHT TIME Minimum time light is activated for prior to opening	0	255	0	1	SEC	5
ON BEFORE CLOSE CYCLE LIGHT TIME Minimum time light is activated for prior to closing	0	25.5	0	1	SEC	5

MENU 6 MOTOR SETTINGS

The motor settings adjust various aspects of the gate travel. When a single gate installation is used the SYNC DELAY TIMES and M2 settings are ignored. The default value for the CLOSE SYNC DELAY time is automatically calculated for LIMIT

SWITCH/AMP TRAVEL installations. The value calculated is selected so that the delay between M2 and M1 reaching the close position is equal to the OPEN SYNC DELAY TIME. The MAX OVERRUN TIME is set to 0 for TIMED TRAVEL installations.

PARAMETER	MIN	MAX	DEFAULT	STEP	UNITS	MENU #
CLOSE SYNC DELAY TIME Time delay between M2 and M1 closing	0.0	25.5	Auto (2.0)	0.1	SEC	6
OPEN SYNC DELAY TIME Time delay between M1 and M2 opening	0.0	25.5	2.0	0.1	SEC	6
OPEN SPEED VOLTS Voltage applied to motors when opening	12	24	22	1	VOLTS	6
CLOSE SPEED VOLTS Voltage applied to motors when closing	12	24	20	1	VOLTS	6
STOP PAUSE TIME Pause time used between motor direction changes	0.0	2.0	0.2	0.1	SEC	6
M1 NORMAL OPEN TIME Normal open time for motor 1	0.0	60.0	0.0	0.1	SEC	6
M1 NORMAL CLOSE TIME Normal close time for motor 1	0.0	60.0	0.0	0.1	SEC	6
M2 NORMAL OPEN TIME Normal open time for motor 2	0.0	60.0	0.0	0.1	SEC	6
M2 NORMAL CLOSE TIME Normal close time for motor 2	0.0	60.0	0.0	0.1	SEC	6
MAX OVERRUN TIME Extra time allowed for cycle to complete (beyond normal cycle time)	0	60	5 (0)	1	SEC	6

MENU 7 OPERATING MODES

P.E INPUT RESPONSE MODE

The P.E input can be configured to respond in one of three modes.

OPEN AND CLOSE CYCLES STOP - In this mode all cycles are prevented from being completed or initiated when the P.E input is active.

CLOSE CYCLES STOP - In this mode the P.E input has no effect when opening but will stop the gate when closing.

REVERSES CLOSE CYCLES - In this mode the P.E input has no effect when opening but will cause the gate to reverse if activated when closing.

PED INPUT FUNCTION

The PED input can be configured to a SWIPE type input for

pedestrian access. This provides full functionality with the P.E Triggered Pedestrian auto-close function.

REMOTE CODE

The controller supports the Remote Code Set feature. This parameter can be used to disable the feature for security or transmitter management reasons.

ACTIVITY REPORTS & ACTIVITY REPORT ID

This parameter selects an activity report output. The ID number is used to select the ID of the controller. Contact ATA for more details

CONTROL BOARD ADJUSTMENTS (cont)

MENU 7 OPERATING MODES (cont)

VACATION MODE

Vacation mode can be turned on or off using this parameter.

BATTERY / SOLAR MODE

The controller can be instructed to turn off the battery backup facilities so that the control board can be shut down without having to disconnect the battery backup system.

PASSWORD PROTECTION

The password feature enables all parameters and configuration settings to be protected unless a password is entered. When this feature is turned on the user is requested to enter the desired password to be used. The password protection feature has a timeout that expires after 60 seconds of inactivity. Alternately the user may log out manually by pressing exit when the main screen is displayed.

TRANSMITTER # GROUPING

The transmitter store number display format can be changed to show a grouped format. When grouping is selected, instead of displaying the store location as a number between 1 and 511, it is displayed as ##\$ where ## is the group number and \$ is a character a,b,c,d,e,f,g or h which indicates the group member.

OPEN AND STOP INPUT POLARITY

The OPN and STP inputs are normally configured for N/O operation. These parameters allows the input's operation to be changed to N/C.

OUTPUT 1 & 2 FUNCTION

This parameter selects functions assigned to OUTPUTS 1 & 2.

EZY PLOT MOTOR

This parameter selects which motor is used for Ezyplot reporting.

OPEN INPUT = 2ND P.E INPUT

The OPN input can be configured to operate as a 2nd P.E input with the same P.E input response mode as that selected for the standard P.E input. The 2nd P.E input is used to alter the P.E triggered auto-close feature so that P.E triggered auto-close is only initiated when the gateway is exited. The direction of travel is determined by the sequence in which the two P.E inputs are triggered. The OPN input's P.E beam is mounted on the inside of the gateway while the P.E input's P.E beam is located at or outside the gateway. For an exit to be detected the inputs must be activated in the following sequence: OPN input activated, P.E input activated, OPN input deactivated, P.E input deactivated.

PARAMETER	MIN	MAX	DEFAULT	STEP	UNITS	MENU #
P.E INPUT RESPONSE MODE Sets the P.E response mode. Options are OPEN and CLOSE cycles stop, Close cycles stop or Close cycle reverse	OPN&CLS stop CLS to stop CLS to Reverse		CLS to Reverse			7
PED INPUT = SWIPE MODE Selects the PED input functions as pedestrian access swipe input.	OFF	ON	OFF			7
REMOTE CODE ENABLED Selects remote transmitter coding function	OFF	ON	ON			7
ACTIVITY REPORTS Select report to be output	OFF	255	OFF	1		7
ACTIVITY REPORT ID Selects ID for controller, sent with activity report	0	65535	0	1		7
VACATION MODE Selects vacation mode - disables remote control.	OFF	ON	OFF			7
BATTERY / SOLAR MODE Selects Battery Backup / Solar operation	OFF	ON	ON			7
PASSWORD Selects password protection for all changes.	OFF	ON	OFF			7
TX # GROUPING Selects tx'er number group display format.	OFF	ON	OFF			7
OPN INPUT N/C OPERATION Selects operating polarity of OPN input	OFF	ON	OFF			7
STP INPUT N/C OPERATION Selects operating polarity of OPN input	OFF	ON	OFF			7
OUTPUTS 1&2 Selects function of OUTPUT1 and OUTPUT2	OUT1 = LOCK OUT2 = LIGHT	OUT1 = LIGHT OUT2 = LOCK	OUT1 = LOCK OUT2 = LIGHT			7
EZY PLOT USES MOTOR Selects motor for Ezyplot reporting	1	2	1	1		7
OPN INPUT = 2ND P.E Open input acts as 2nd P.E input	OFF	ON	OFF			7

PARAMETER VIEWING AND EDITING

The control board has many parameters which modify its operation. This section illustrates how the parameters are located , viewed and adjusted.

STEP 1. LOCATING PARAMETERS

Using the MENU STRUCTURE figure or the relevant section within CONTROL BOARD ADJUSTMENTS, locate the parameter of concern and obtain the MENU number which contains it. For illustration purposes “CLOSE LOCK TIME” will be used as an example. From the table it can be seen that CLOSE LOCK TIME is located in MENU 4.

STEP 2. NAVIGATE TO MENU

From the MAIN SCREEN, Use NEXT / PREV to navigate to the required menu (MENU 4), press SET to show the parameter list.

STEP 3. VIEW PARAMETER

The controller is now in VIEW MODE and the first parameter in the list will be displayed. Using the NEXT / PREV buttons step through the list of parameters until the required parameter is displayed.

If the parameter’s value is not to be changed then skip to step 7 when finished viewing the parameters.

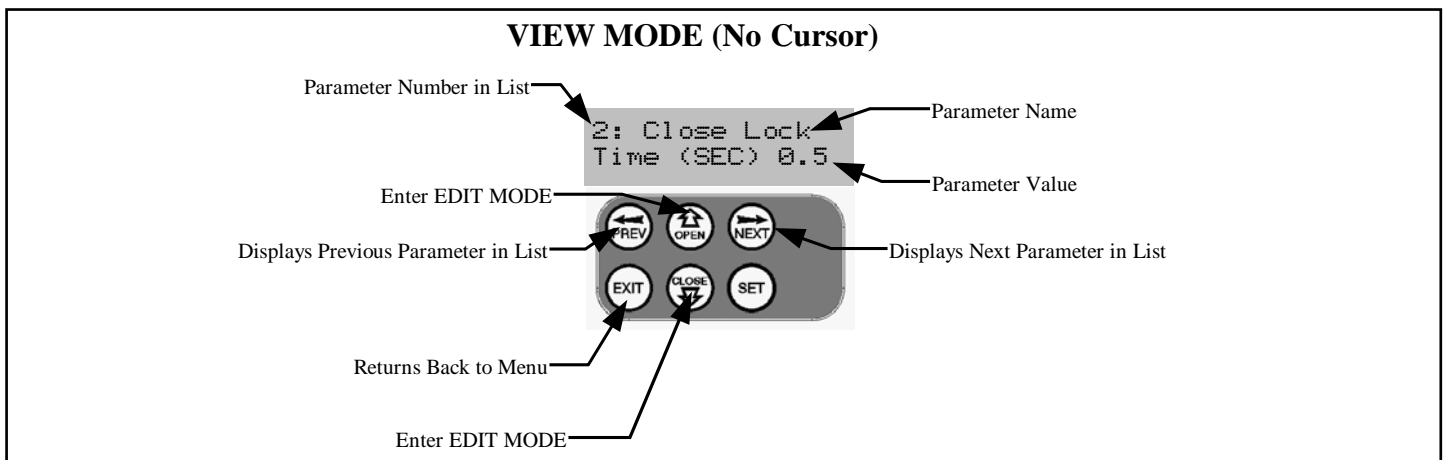

STEP 4. EDIT PARAMETER

Press the UP or DOWN button to display a cursor on the parameter’s value. The controller is now in EDIT MODE. With each press of the UP or DOWN button the parameter value will change. Holding the button down causes the parameter’s value to change rapidly. The longer the button is held the faster the value changes.

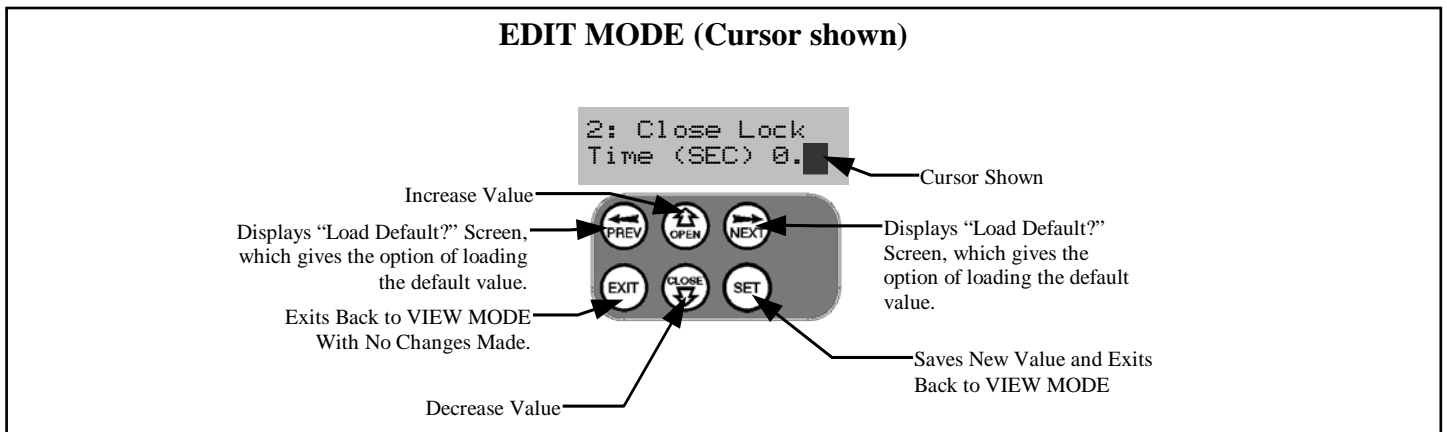

STEP 5. RELOADING DEFAULT

To load the parameter’s default setting, press the NEXT or PREV buttons to display the LOAD DEFAULT screen, press SET to load the default value.

STEP 6. SAVING CHANGES

To save the new value press SET. To leave without saving changes, press EXIT. In both cases EDIT MODE will exit and VIEW MODE will be re-entered

STEP 7. FINISHING UP

Press EXIT to return to the MENUS and then press EXIT again to return to the MAIN SCREEN.

TRANSMITTER OVERVIEW

The controller can store 30 transmitters within its memory. Each transmitter can be allocated an ID label and each button can be assigned to one of several control functions. The settings for a transmitter are represented using the screen shown to the right. It shows the Transmitter's store number, the ID label or Serial number and the functions assigned to each of its four buttons. The ID / SN display is toggled by pressing UP/DOWN with the cursor on the ID/SN indicator. The procedures below code, delete, replace, edit and copy transmitter records.

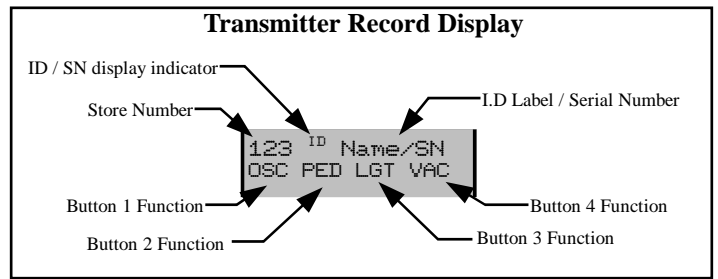

BASIC CODE TRANSMITTER PROCEDURE

THE PROCEDURE BELOW IS USED TO ADD A TRANSMITTER BUTTON TO THE CONTROLLER'S MEMORY.

STEP 1. NAVIGATING TO "Code Transmitter" MENU

To navigate to the Menu 1 from the main screen simply press NEXT. Press SET to start the Transmitter Code procedure.

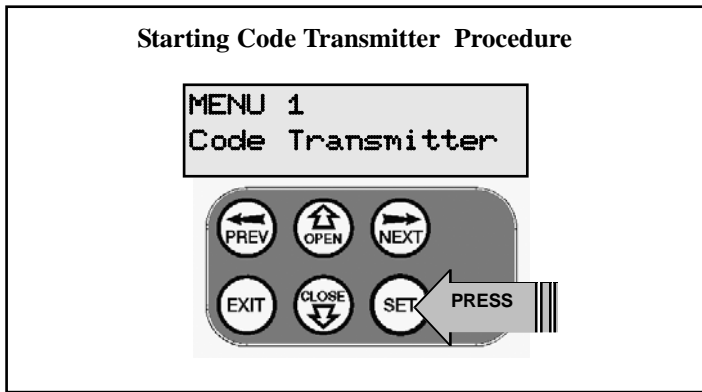

STEP 2. RECORDING THE TRANSMITTERS CODE

The controller will prompt for you to press one of the transmitter's buttons. Simply press the transmitter button you wish to use to operate the Gate Opener. Button 1 is used for example.

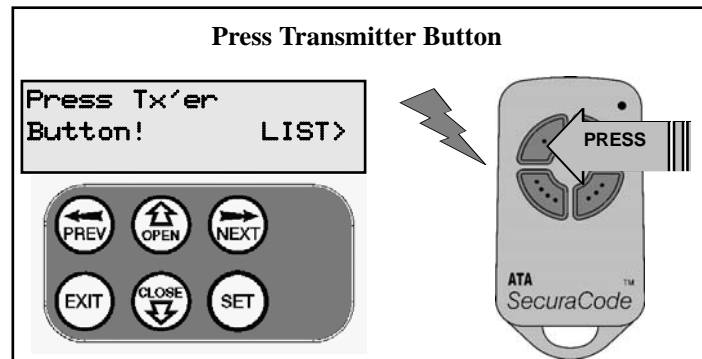

The controller will respond by prompting for the button to be pressed again for verification. Press the transmitter button again.

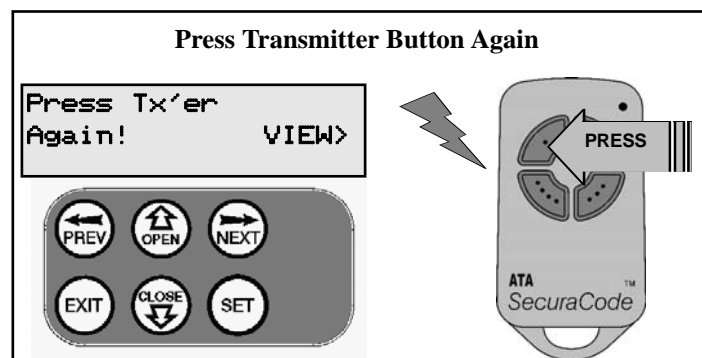

STEP 3. SELECTING FUNCTION OF THE BUTTON

The controller will now show the transmitter's record, with a cursor on the field for the button being coded. Use UP/ DOWN to select the function for the button.

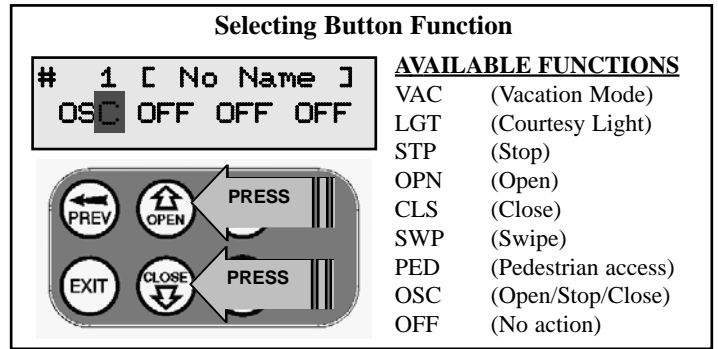

If desired, you can continue and edit the other settings, for details see **TRANSMITTER EDIT PROCEDURE**.

STEP 4. SAVING THE CHANGES

Press SET to save the settings or EXIT to abort without saving.

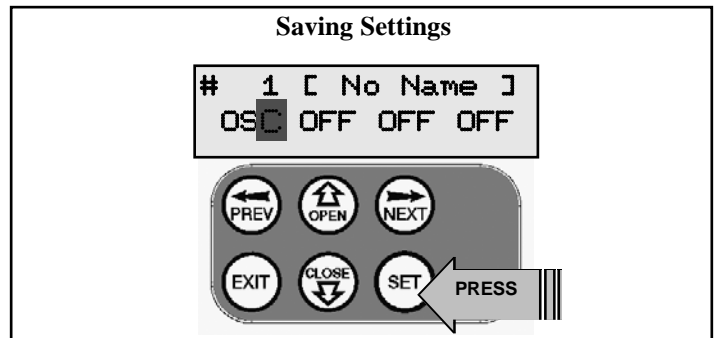

STEP 5. RETURNING TO MAIN SCREEN

The "Code Transmitter" menu will now be shown. Press EXIT to return to the MAIN SCREEN and test the transmitter.

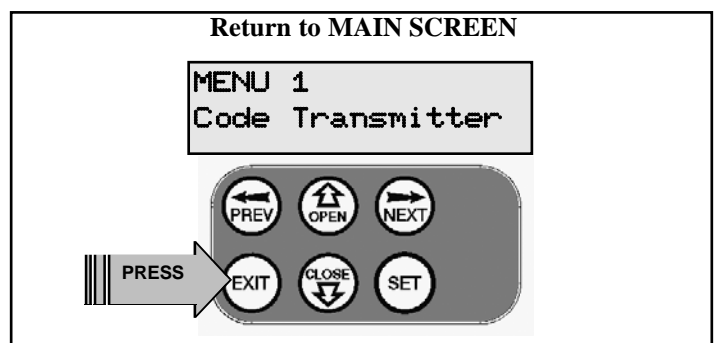

TRANSMITTER EDIT PROCEDURE

THE PROCEDURE BELOW IS USED TO EDIT THE DISPLAYED TRANSMITTER'S SETTINGS.

STEP 1. DISPLAY TRANSMITTER RECORD

Using one of the methods below, display the required transmitters details.

1. Follow the BASIC CODE TRANSMITTER PROCEDURE to STEP 3 for a new or existing transmitter.
2. Select EDIT when LISTING TRANSMITTERS

STEP 2. SELECTING THE FIELD TO EDIT

Select the desired field by using NEXT or PREV to move the cursor to the left or right and between the top and bottom lines.

STEP 3. EDITING THE BUTTON FUNCTION FIELDS

Perform this step if one of the button function fields is selected. Use UP and DOWN to change the displayed value. The available functions are shown below. Selecting OFF will prevent the controller responding to the button at all. When the correct setting has been made repeat STEP 2 to select the next field to edit or continue with STEP 7. The example below shows editing the function assigned to the transmitter button 2. The transmitter in the example is transmitter number 123 which has a label of AB Smith.

Selecting Button Function

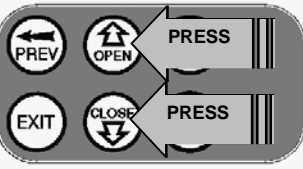
<div style="border: 1px solid black; padding: 2px; margin-bottom: 5px;"> <p>123 ID A B SMITH OSC PE █ LGT VAC</p> </div> 	<p>AVAILABLE FUNCTIONS</p> <p>VAC (Vacation Mode) LGT (Courtesy Light) STP (Stop) OPN (Open) CLS (Close) SWP (Swipe) PED (Pedestrian access) OSC (Open/Stop/Close) OFF (No action)</p>
--	---

STEP 4. EDITING THE STORE LOCATION

This feature is only available when editing is initiated by coding the first button of a new transmitter. When the cursor is moved to the store number field, the UP and DOWN buttons step through the available store locations. This is useful when managing transmitters using a scheme which ties the store location to the transmitter's owner.

Selecting a Shore Location Number

124 ID A B SMITH
OSC PED LGT VAC

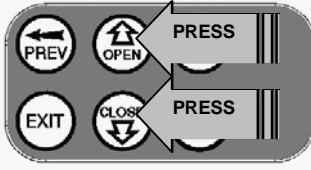

STEP 5. SELECTION OF ID OR SN DISPLAY

When the cursor is moved to the ID/SN indicator, the UP and DOWN buttons toggle between displaying the ID label and the transmitters serial number. The serial number display is provided for an additional means of transmitter management. The transmitter in the example has a serial number of 123456789.

Displaying Serial Number

124 SN █ 123456789
OSC PED LGT VAC

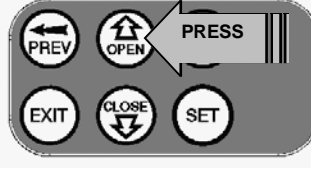

STEP 5. EDITING A CHARACTER FIELD

Perform this step if one of the character fields of the transmitter name is selected. Press UP or DOWN to change the selected

Character For Name Selected

124 ID █ B SMITH
OSC PED LGT VAC

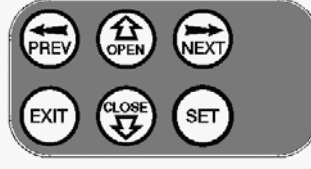

character. When a change is made the bottom line of the display will show a list of available characters to choose from with the current value indicated at the cursor position. When the correct character has been selected repeat STEP 2 to select the next field to edit or continue with STEP 7.

Character For Name Edited

124 ID B B SMITH
56789 A █ CDEFGHIJ

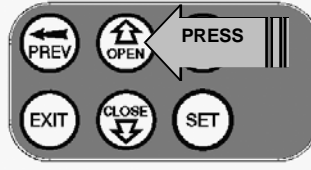

STEP 7. SAVING THE CHANGES

Press SET to save the settings or EXIT to abort without saving. **NOTE** If all button functions are set to OFF then when SET is pressed, the controller will prompt to confirm the transmitter is to be deleted. Press SET to delete or EXIT to continue editing.

Saving Changes

124 ID █ B SMITH
OSC PED LGT VAC

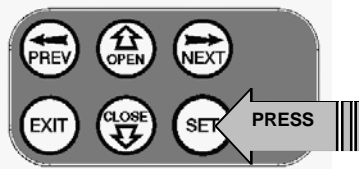

TRANSMITTERS LIST MANAGEMENT

THE CONTROLLER PROVIDES A TRANSMITTER LISTING FACILITY WHICH ENABLES THE USER TO FIND A TRANSMITTER LOCATION WITHIN ITS MEMORY. ONCE LOCATED, A STORED TRANSMITTER CAN BE REPLACED, DELETED, EDITED, COPIED OR, IF THE LOCATION IS EMPTY, A TRANSMITTER CODED INTO IT.

STEP 1 ACCESSING THE LIST

METHOD 1. GO TO START OF LIST

The list be be accessed by selecting the “Code Transmitter” MENU (as in STEP 1 of the BASIC CODE TRANSMITTER PROCEDURE), followed by pressing NEXT. This will display the list with transmitter number 1 shown.

Access The Code Transmitter MENU

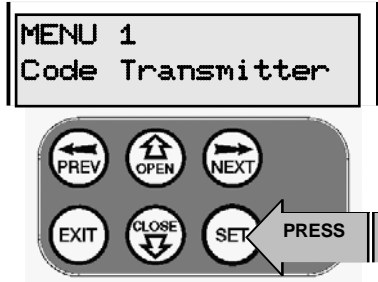

Displaying The List starting at Transmitter #1

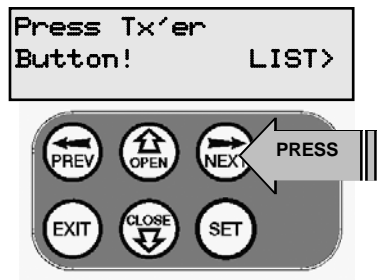

List with Transmitter #1 shown

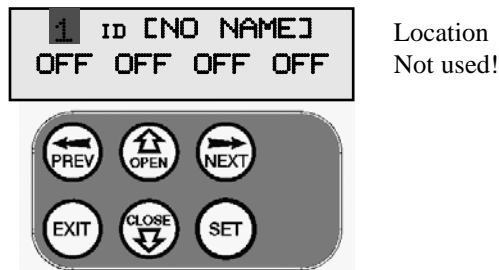

METHOD 2. GO TO A TRANSMITTER'S LOCATION WITHIN LIST

A particular transmitter's location within the list can be displayed by selecting the “Code Transmitter” MENU (as in STEP 1 of the BASIC CODE TRANSMITTER PROCEDURE), followed by pressing any one of the transmitter's buttons.

When the “Press Tx'er Again” message is displayed press NEXT to display the transmitter's location within the list. NOTE “VIEW>” will not be shown if the transmitter is not stored.

Access The Code Transmitter MENU

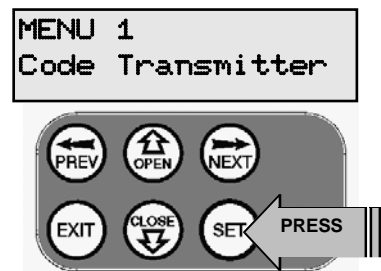

Press Transmitter Button

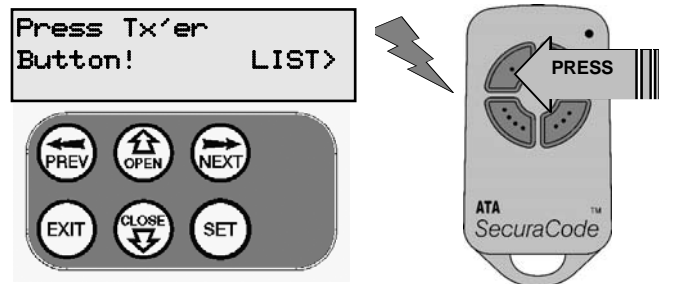

Display Transmitter's Location In List

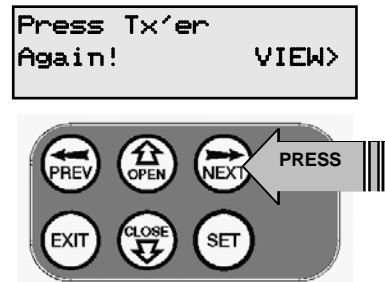

List with Transmitter's location shown



TRANSMITTERS LIST MANAGEMENT (cont)

STEP 2. NAVIGATING THE LIST

Once the list is displayed it can be sorted by Store number , ID Label or Serial number. Use the NEXT and PREV button to select the sorting method. Note when sorting by ID label or Serial number, only stored transmitters locations are displayed. The UP and DOWN buttons can be used to navigate through the list. Note holding a button down will step through the list faster.

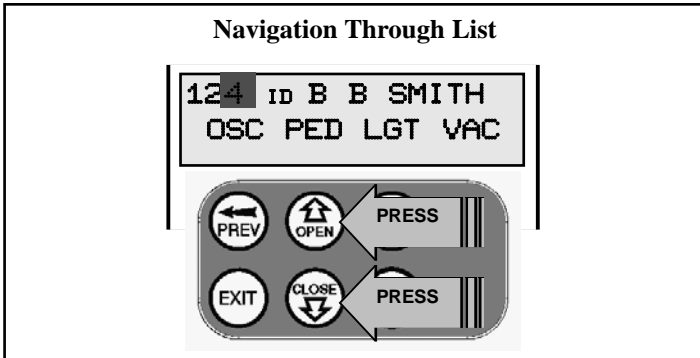

STEP 3. SELECTING LOCATION TO MODIFY.

When the desired location is displayed press the SET button to display a menu of available functions that can be performed on the location. The example uses transmitter number 124.



STEP 4. SELECTING AN OPERATION

The four menus below are displayed by repeated presses of the NEXT or PREV buttons. Pressing EXIT will return back to the list (STEP 2). Pressing SET will execute the menu's operation.

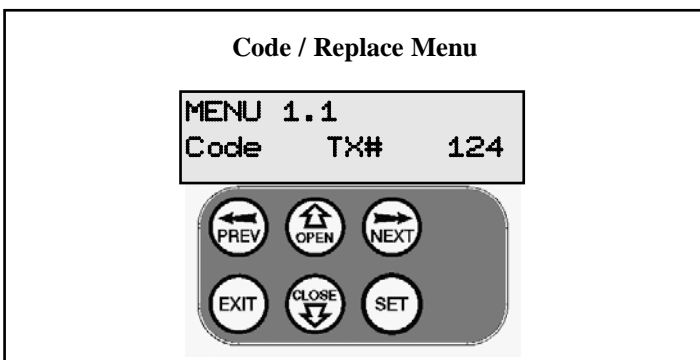

CODE OPERATION (LOCATION EMPTY)

If the code operation is selected on an empty transmitter location, the BASIC CODE TRANSMITTER PROCEDURE will be initiated with the transmitter being saved in the selected location. This is useful when managing transmitters using a scheme which ties the store location to the transmitter's owner.

CODE OPERATION (LOCATION USED)

If the code operation is selected for a location that already

contains a transmitter, then the BASIC CODE TRANSMITTER PROCEDURE will be initiated and the new transmitter will replace the existing one. Note that the button functions and name of the existing transmitter will be transferred to the new transmitter. This procedure is of great convenience when replacing a lost transmitter.

DELETE OPERATION

The delete operation is used to remove a transmitter from memory along with the name and button function settings.

Delete Transmitter Menu

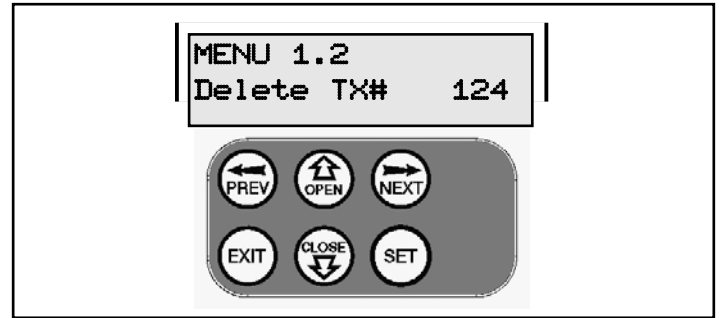

EDIT OPERATION

The edit operation displays the transmitter record for editing purposes. See TRANSMITTER EDIT PROCEDURE for details.

Edit Transmitter Menu

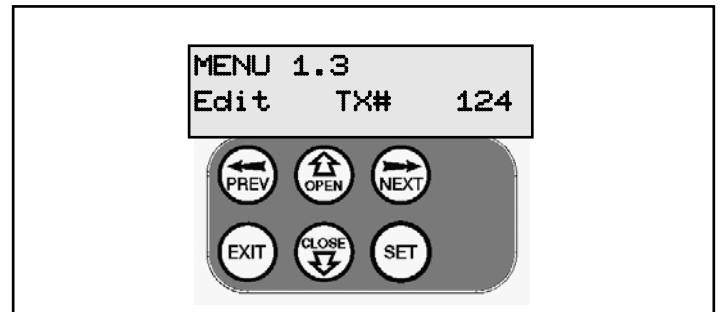

COPY OPERATION

The copy operation is used to code multiple transmitters with the same button function as that of the selected transmitter. Once selected an abbreviated code set routine is initiated which repeats steps 2 & 3 of the BASIC CODE TRANSMITTER PROCEDURE for each transmitter to be coded. The coding is terminated by pressing the EXIT button.

Edit Transmitter Menu

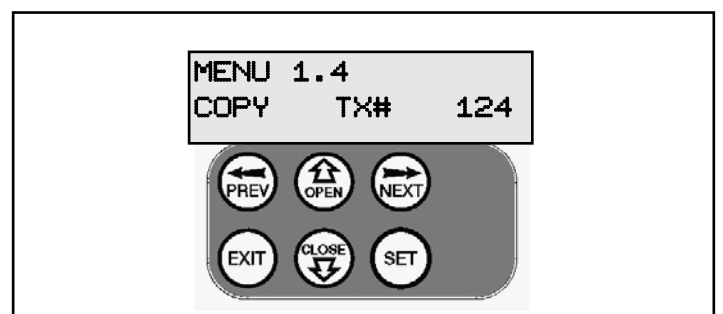

STEP 6. EXITING THE LIST

To exit the transmitter list simply press EXIT to return to the Code Transmitter Menu.

REMOTE CODE SET PROCEDURE

THE CONTROLLER PROVIDES A REMOTE CODE SET FEATURE WHERE BY AN EXISTING TRANSMITTER BUTTON CAN BE USED TO CODE A NEW TRANSMITTER BUTTON INTO THE CONTROLLER MEMORY.

NOTE ONLY THE FUNCTION OF THE EXISTING TRANSMITTER BUTTON CAN BE ASSIGNED TO THE NEW TRANSMITTER. PLEASE READ THE INSTRUCTION PRIOR TO CARRYING OUT THE STEPS AS THE PROCEDURE HAS A TIMEOUT FACILITY FOR SECURITY REASONS.

STEP 1 SELECTING THE FUNCTION TO BE CODED

Using the existing transmitter, operate the gate with the transmitter button which has the function to be coded.

As an example the existing transmitters Button 1 has been coded with the OSC function assigned to it.

Operate Gate Using Existing Transmitter Button

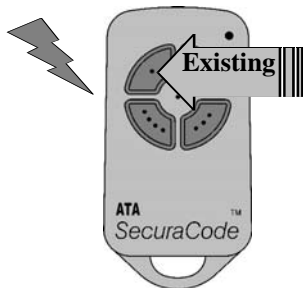

STEP 2. WAIT FOR GATE TO COMPLETE CYCLE

If the button's function activates the gate (PED, SWP, OSC, CLS, STP or OPN) wait for the gate to complete its cycle.

STEP 3. ACTIVATE REMOTE CODE SET MODE

Using a small needle press and hold firmly for two seconds through the Coding Hole of the existing transmitter.

Activate Remote Code Set Mode

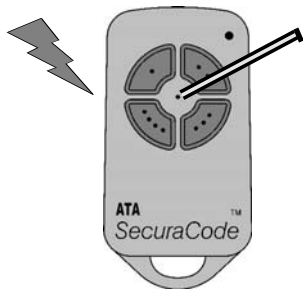

STEP 4.. CODE NEW TRANSMITTER BUTTON

Within 10 seconds, activate the new transmitters button you wish to code for 2 seconds. The example shows Button 1 being used but it could be any button. It can even be an unused button on the existing transmitter

Operate New Transmitter Button To Be Coded

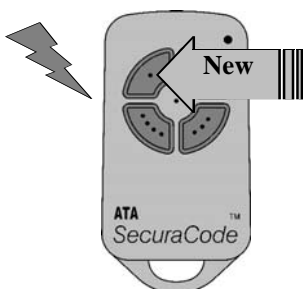

STEP 5.. CONFIRM TRANSMITTER BUTTON TO BE CODED

Within 10 seconds, activate the new transmitters button again for 2 seconds for confirmation

Confirm New Transmitter Button To Be Coded

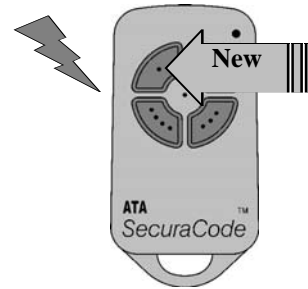

STEP 6.. TEST OPERATION

The new transmitter button should now function as the existing transmitter button did.

NOTE ON CODED TRANSMITTER'S ID LABEL

When a transmitter is remote coded, its ID label is set that that of the existing transmitter. If the existing transmitter does not have an ID label assigned, then the ID label of the new transmitter is set to: R/C Tx ### where ### is the existing transmitters store number. This ensures that the originator of any remote coded transmitter can be identified

DIAGNOSTIC TOOLS

THE CONTROLLER PROVIDES SEVERAL DIAGNOSTIC TOOLS FROM WITHIN THE DIAGNOSTICS MENU (MENU 8) THIS SECTION DETAILS THE FUNCTION OF EACH TOOL AND ITS USE.

NAVIGATING TO THE DIAGNOSTICS MENU

The Diagnostic tools are accessed by selecting the Diagnostics menu (MENU 8). Use PREV or NEXT to display each of the diagnostic tool menus in turn.. When the required tool's menu is displayed simple press SET to access it.

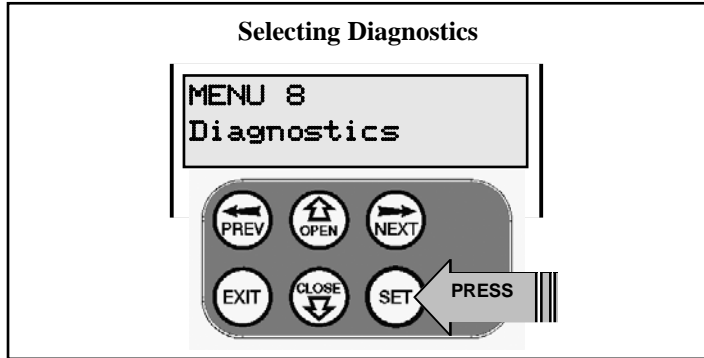

The controller will then beep each time a transmission is received. If the transmitter button is stored in the controller memory and has a function assigned to it, a second screen will be displayed that shows the transmitter details along with the button pressed. The example below shows the case when transmitter number 124 is activated by button 4. Note ID is selected for display.

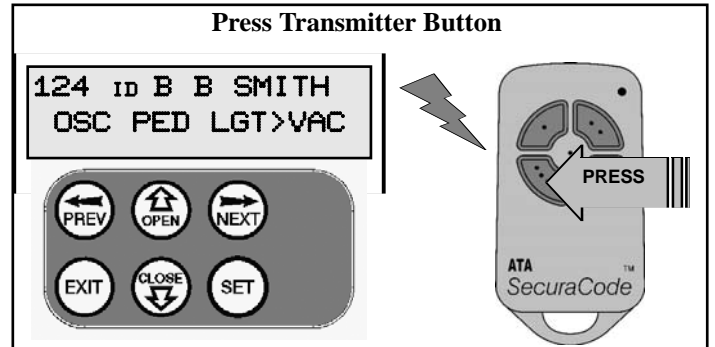

THE SECTIONS BELOW DETAIL THE FUNCTION OF EACH TOOL.

MENU 8.1 TEST INPUTS

This tool is used to view the state of the control inputs. When selected, a screen is displayed (see below) which indicates the state of each input. If the name of the input is in uppercase then the input is active, conversely is the input is in lower case then the input is inactive. For normal operation all inputs should be inactive. When finished press EXIT. The example below shows the status shown when the OSC input is active.

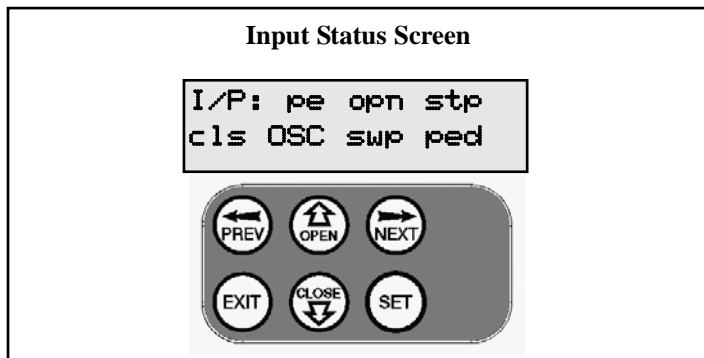

MENU 8.3 DISPLAY HISTORY

The controller keeps a record of the last 64 events that have taken place. The events include the type of drive cycles executed, obstruction detection, various faults, power failures etc. When this tool is selected a screen is displayed (see below) which displays the last event that occurred. The NEXT and PREV buttons can be used to view each event. The "EVENT#" field shows the sequence of the events, with 1 being the first and 64 being the last. The example below shows that the last event was a close cycle which succeeded in closing the gate. When finished viewing the events, simply press EXIT



MENU 8.2 TEST TX'ERS

This tool is used to test receiver / transmitter functionality. When selected, a screen is displayed which prompts for a transmitter button to be pressed and whether ID or serial numbers are to be displayed..

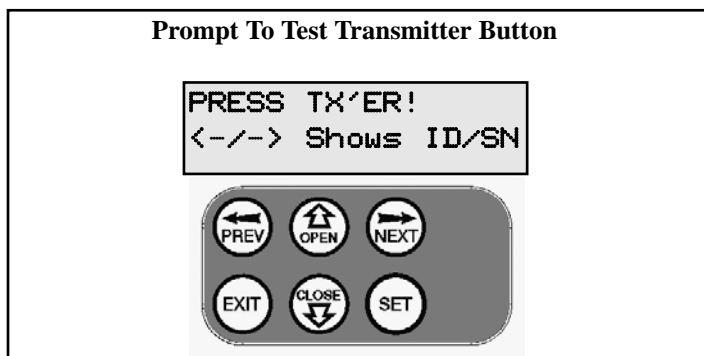

MENU 8.4 MEMORY USAGE

This tool displays the number of transmitter store location used and the number free.

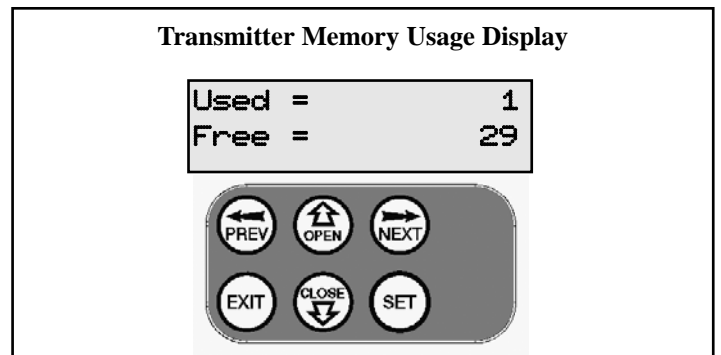

DIAGNOSTIC TOOLS (cont)

MENU 8.5 SERVICE COUNTER The controller provides a periodic service counter which can be set to expire after a number of drive cycles. When expired, the controller will beep at the beginning of each drive cycle and a message will be displayed on the MAIN SCREEN. This tool displays the current value of the service counter and allows the user to set its value using the normal parameter editing techniques (See PARAMETER VIEWING AND EDITING). If the service counter is not to be used it can be set to the maximum number which requires 60,000 cycle before service will be due. The example below shows the service counter with a value of 60000.

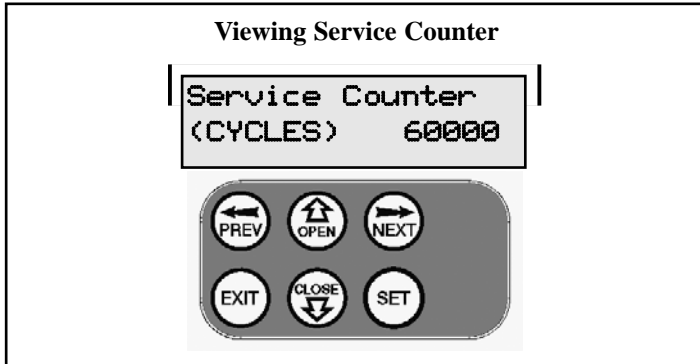

MENU 8.6 COUNTERS

The controller keeps a count of number of times a particular event occurs. The list of event counters kept is shown below. When this tool is selected the first event counter is shown. The NEXT and PREV buttons are used to step through the list. The example below shows the OPEN CYCLE event counter with a value of 1234. When finished viewing simply press EXIT.

- | | |
|---------------------------|------------------------|
| 1: Open Cycles | 14: M2 Close Overloads |
| 2: Close Cycles | 15: M1 Drive Faults |
| 3: Ped Cycles | 16: M2 Drive Faults |
| 4: Warranty Cycles | 17: M1 Volt Faults |
| 5: Setup Limits | 18: M2 Volt Faults |
| 6: Overlaps | 19: M1 Amp Faults |
| 7: M1 Open Obstructions | 20: M2 Amp Faults |
| 8: M2 Open Obstructions | 21: Supply High Faults |
| 9: M1 Close Obstructions | 22: Supply Low Faults |
| 10: M2 Close Obstructions | 23: M1 Amp Trip Faults |
| 11: M1 Open Overloads | 24: M2 Amp Trip Faults |
| 12: M2 Open Overloads | 25: 3WIRE Limit Faults |
| 13: M1 Close Overloads | |

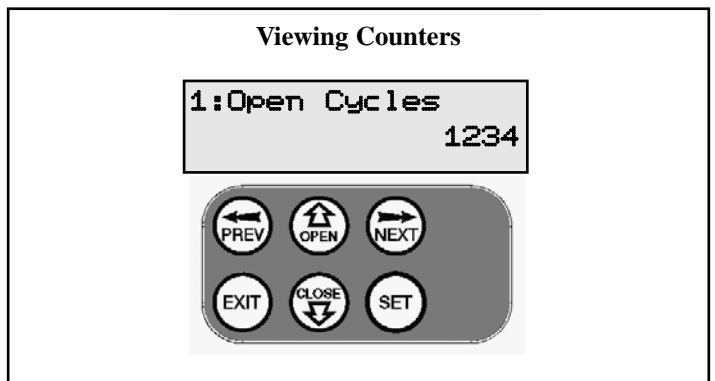

MEMORY TOOLS

The Memory Tools accessed from within Menu 9 are used to clear the controller's memory. Once selected the PREV or NEXT buttons can be used to view the Memory Tool options. To Execute the displayed option simply press SET.

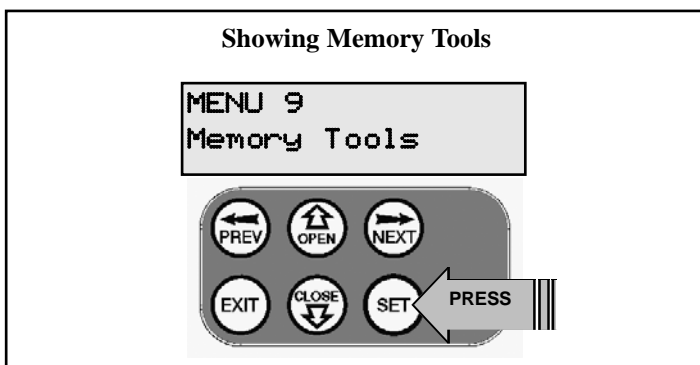

MENU 9.1 CLR CONTROL

This option will clear the gate control memory and reload the factory set defaults for parameters such as the lock time, light time, auto-close times etc. It will also clear the travel limits.

MENU 9.2 CLR TX'ERS

This option will clear the transmitter storage memory.

SPECIFICATIONS

TECHNICAL SPECIFICATIONS

CONTROLLER SUPPLYVOLTAGE:	24V AC 50Hz & 10AMP MAX
24VDC ACCESSORY OUTPUT:	24VDC (unfiltered) @ 3A max
MOTOR VOLTAGE:	12-24V DC @ 10AMP MAX Combined
OUTPUT 1:	240VAC / 24VAC / 30VDC @ 5AMPS
RECEIVER TYPE:	UHF 433.92 MHz. AM Receiver
RECEIVER CODE STORAGE CAPACITY:	30 x 4 Button Transmitter Codes
TRANSMITTER FREQUENCY:	433.92 MHz
CODING TYPE:	Hopping Code
No. of CODE COMBINATIONS:	Over 4.29 Billion Random Codes
CODE GENERATION:	Non-linear Encryption Algorithm
TRANSMITTER BATTERY:	A23 Alkaline 12 Volts

Please Note: Specifications are subject to change without notice.

WARRANTY AND EXCLUSION OF LIABILITY

Subject to all of the matter set out below, Automatic Technology Australia Pty Ltd ("ATA") warrants for twelve (12) months from the date of purchase (specified in the receipt sales docket) that the CB19 controller contained in the accompanying packaging (the "Product") is free of any defects in material and workmanship rendering it unmerchantable.

This warranty referred to above applied only where:

- a) the consumer seeking to rely on the said warranty;
 - 1) returns the Product which it claims to be defective; and
 - 2) presents the relevant sales docket and this warranty document,

To the retailer from whom the Product was purchased to confirm that date of purchase; and

- b) the purchaser notified ATA or the retailer from whom the Product was purchased of the alleged defect in the Product immediately upon experience or learning of the alleged defect.

Except for the warranty against defects in material and workmanship set out above, ATA gives no warranties of any kind whatsoever, whether express or implied or whether statutory or at common law, in relation to the Product, and all warranties of fitness for particular purpose and other warranties of whatsoever kind relating to the Product are hereby disclaimed. Without limiting the generality of the foregoing, ATA disclaims any liability of whatsoever nature in respect of any claim or demand loss or damage which arise out of;

- a) accidental damage to or normal wear and tear to the Product or to the Product's components;
- b) flood, rain, water, fire or lightning;
- c) incorrect, improper or unreasonable maintenance and/or use;
- d) installation, adjustment or use other than ATA which is not in accordance with the instructions set out in installation instructions incorporated in the document;
- e) attempted or complete modification or repairs to the Product carried out by a person who is not authorised by ATA to carry out such modification or repairs;
- f) faulty or unsuitable wiring of structure to which the Product is fixed or connected; and
- g) radio (including citizen band transmission) or any electronic interference.
- h) blown fuses or damage caused by electrical surges.
- i) damage caused by insects.

ATA's liability under the warranty set out above is limited, at ATA's absolute option, to replacing or repairing the Product which ATA, in its unfettered opinion, considers to be defective either in material and/or workmanship or to credit the consumer with the price at which the Product was purchased by the consumer.

Where the Product is retailed by any person other than ATA, except for the warranty set out above, such person has no authority from ATA to give any warranty or guarantee on ATA's behalf in addition to the warranty set out above.

AUTOMATIC TECHNOLOGY AUSTRALIA PTY LTD

ABN 11 007 125 368

6-8 Fiveways Blvd, Keysborough, Victoria, Australia 3173

Tel: +61 3 9791 0200 Fax: +61 3 9791 0250

Web: www.ata-aust.com.au Email: sales@ata-aust.com.au